

**GOVT. OF ODISHA**

**DIRECTORATE OF TECH. EDN.& TRG,  
ODISHA, CUTTACK**

**SCTE&VT, ODISHA**

***LR MATERIALS 6<sup>TH</sup> SEM ELECTRICAL***

**Subject:  
ELECTRICAL INSTALLATION AND  
ESTIMATING**

**6<sup>TH</sup> SEM ELECTRICAL INSTALLATION  
AND ESTIMATING-LR**

## EXTRACTS FROM INDIAN ELECTRICITY RULES - 1956

The Indian Electricity Rules have been framed to ensure safety, satisfactory operation of equipment and to avoid fire risk. Important extracts from these Rules are given below:

**29. Construction, installation, protection, operation and maintenance of electric supply lines and apparatus.** All electric supply lines and apparatus shall be of sufficient in mechanical strength and size for the work they may be required to do and shall be constructed, installed and protected in accordance with I.S.I's specifications.

**30. Service lines and apparatus on consumer's premises.**(1) the supplier shall ensure that all electric supply lines, wires, fittings, and apparatus belonging to him or under his control which are on a consumer's premises are in a safe condition and in all respects fit for supplying energy, and the supplier shall take due precautions to avoid danger arising on such premises from such supply lines, fittings and apparatus.

(2) Service-lines placed by the supplier on the premises of a consumer which are underground or which are accessible shall be so insulated and protected by the supplier as to be secured unde all ordinary conditions against electrical, mechanical, chemical or other injury to the insulation.

(3) The consumer shall, as far as circumstances permit, take precautions for the safe custody of the equipment on his premises belonging to the supplier.

(4) The consumer shall also ensure that the installation under his control is maintained in a safe condition.

**31. Cut-out on consumer's premises** - (1) The supplier shall provide a suitable cut-out in each conductor of every service line other than an earthed or earthed neutral conductor or the earthed external conductor of a concentric cable within a consumer's premises, in an

accessible position. Such cut-out shall be contained within an adequately enclosed fire-proof receptacle.

Where more than one consumer is supplied through a common service-line, each such consumer shall be provided with an independent cut-out at the point of junction to the common service.

(2) The owner of every electric supply line other than the earthed or earthed neutral conductor of any system or the earthed external conductor of a concentric cable shall protect it by a suitable cut-out.

**32. Identification of earthed and earthed neutral conductors and position of switches and cut-outs therein** - Where the conductors include an earthed conductor of a two wire system or an earthed neutral conductor of a multi-wire system or a conductor which is to be connected thereto, the following conditions shall be complied with:-

- (1) An indication of a permanent nature shall be provided by the owner of the earthed or earthed neutral conductor, or the conductor which is to be connected thereto to enable such conductor to be distinguished from any live conductor. Such indication shall be provided-
  - (a) Where the earthed or earthed neutral conductor is the property of the supplier, at or near the point of commencement of supply.
  - (b) Where a conductor forming part of consumer's system is to be connected to the supplier's earthed or earthed neutral conductor, at the point where such connection is to be made;
  - (c) In all other cases, at a point corresponding to the point of commencement of supply or at such other points as may be approved by an Inspector.
- (2) No cut-out, link or switch other than a linked switch arranged to operate simultaneously on the earthed or earthed neutral conductor and live conductors shall be inserted or remain inserted in any earthed or earthed neutral conductor of a two

wire system or in any earthed or earthed neutral conductor of a multi-wire system or in any conductor connected thereto with the following exceptions:-

- (a) A link for testing purposes, or
- (b) A switch for use in controlling a generator or transformer.

**33. Earthed terminal or consumer's premises** - (1) The supplier shall provide and maintain on the consumer's premises for the consumer's use a suitable earthed terminal in an accessible position at or near the point of commencement of supply as defined under rule 58.

Provided that in the case of medium, high or extra high voltage installation, the consumer shall, in addition to the aforementioned earthing arrangement, provide his own earthing system with an independent electrode:

Provided further that the supplier may not provide any earthed terminal in the case of installations already connected to his system on or before the date to be specified by the State Government in this behalf if he is satisfied that the consumer's earthing arrangement is efficient.

(2) The consumer shall take all reasonable precautions to prevent mechanical damage to the earthed terminal and its lead belonging to the supplier.

(3) The supplier may recover from the consumer the cost of installation of such earthed terminal on the basis laid down in sub-rule (2) of rule 82.

**34. Accessibility of bare conductors** - where bare conductors are used in a building, the owner of such conductors shall -

- (a) Ensure that they are inaccessible;
- (b) Provide in readily accessible position switches for rendering them dead wherever necessary ; and
- (c) Take such other safety measures as are considered necessary by the Inspector.

**35. Caution Notices** - The owner of every medium, high and extra high voltages Installation shall affix permanently caution notices in Hindi, English and Local Language of the District on poles, motors, transformers etc.

**37. Supply to vehicles, cranes etc.** - Every person owning from an external source shall ensure that it is efficiently controlled by a suitable switch enabling all voltage to be cut off in one operation and, where such vehicle, travelling crane or the like runs on metal rails, the owner shall ensure that the rails are electrically continuous and earthed.

**38. Cables for per portable or transportable apparatus** - (1) Flexible cables shall not be used for portable or transportable motors, generators, transformers, rectifiers, electric drills, electric sprays, welding sets or any other portable or transportable apparatus unless they are heavily insulated and adequately protected from mechanical injury.

(2) Where the protection is by means of metallic covering, the covering shall be in metallic connection with the frame of any such apparatus and earth.

**43. Provisions applicable to protective equipment** -(1) Fire buckets filled with clean dry sand and ready for immediate use for extinguishing fires, in addition to fire extinguishers suitable for dealing with electric fires, shall be conspicuously marked and kept in all generating stations, enclosed sub-stations and enclosed switch stations in convenient situations.

(2) First aid boxes or cupboards, conspicuously marked and equipped with such contents as the State Government may specify, shall be provided and maintained in every generating station, enclosed sub-station and enclosed switch station so as to be readily accessible during all working hours. All such boxes and cupboards shall, except in the case of unattended sub-stations and switch stations be kept and charge of responsible persons who are trained in first-aid treatment and one of such persons shall be available during working hours.

**44. Instructions for restoration of persons suffering from electric shock** - (1) Instructions, in English, Hindi and the local language of the district, for the restoration of person suffering from electric shock, shall be affixed by the owner in as conspicuous place in every generating station, enclosed sub-station, enclosed switch station and in every factory as defined in clause (m) of section 2 of the Factories Act, 1948 (LXIII of 1948) in which electricity is used and in such other premises where electricity is used as the Inspector may, by notice in writing served on the owner direct.

(2) Copies of the instructions shall be supplied on demand by an officer or officers appointed by the Central or the State Government in this behalf at a price to be fixed by the Central or the State Government.

(3) The owner of every generating station, enclosed sub-station, enclosed switch-station, and every factory or other premises to which this rule applies shall ensure that all authorized persons employed by him are acquainted with and are competent to apply the instructions referred to in sub-rule (1)

**45. Precautions to be adopted by consumers, owners, electrical contractors, electrical workmen and suppliers** - (1) No electrical installation work, including additions, alterations, repairs and adjustments to existing installations, except such replacement of lamps, fans, fuses, switches, low voltage domestic appliances and fittings as in no way alters its capacity or character, shall be carried out upon the premises of or on behalf of any consumer or owner, for the purpose of supply to such consumer or, owner, except by an electrical contractor licensed in this behalf by the State Government and under the direct supervision of a person holding a certificate of competency issued or recognized by the State Government:

Provided that in the case of works executed for or on behalf of the Central Government and in the case of installations in mines, oil fields and railways, the Central Government and in other cases the State Government may, by notification in the official Gazette, exempt, on such conditions as it may impose, any such work described therein either generally or in the case of any specified class of consumers or owners, from so much of this sub-rule as

requires such work to be carried out by an electrical contractor licensed by the State Government in this behalf.

(2) No Electrical installation work which has been carried out in contravention of sub-rule (1) shall be connected with the works of any supplier.

(3) The provisions of sub-rule (1) shall come into force in any oil field, mine or railway or any State or part thereof on such date as the Central or, as the case may be, the State Government may, by notification in the official Gazette appoint.

**46. Periodical inspection and testing of consumer's installation- (1)**

(a) Where an installation is already connected to the supply system of the supplier, every such installation shall be periodically inspected and tested at intervals not exceeding five years either by the Inspector or by the supplier as may be directed by the State government in this behalf or in the case of installations in mines, oil-fields and railways by the Central Government.

(b) Where the supplier is directed by the Central or the State Government, as the case may be, to inspect and test the installation he shall report on the condition of the installation to the consumer concerned in a form approved by the Inspector and shall submit a copy of such report to the Inspector.

(2) (a) The fees for such inspection and test shall be determined by the Central or the State Government as the case may be, in the case of each class of consumers and shall be payable by the consumer in advance.

(b) in the event of the failure of any consumer to pay the fees on or before the date specified in the fee-notice, supply to the installation of such consumer shall be liable to be disconnected under the direction of the Inspector. Such disconnection, however, shall not be made by the supplier without giving to the consumer seven clear days' notice in writing of his intention so to do.

(3) Notwithstanding the provisions of this rule, the consumer shall at all times be solely responsible for the maintenance of his installation in such condition as to be free from danger.

**47. Testing of consumer's installation.** (1) Upon receipt of an application for a new or additional supply of energy and before connection the supply or reconnecting the same after a period of six months, the supplier shall inspect and test the applicant's installation.

The supplier shall maintain a record of test results obtained at each supply point to a consumer, in a form to be approved by the Inspector.

(2) If as a result of such inspection and test, the supplier is satisfied that the installation is likely to constitute danger, he shall serve on the applicant a notice in writing requiring him to make such modifications as are necessary to render the installation safe. The supplier may refuse to connect or reconnect the supply until the required modifications have been completed and he has been notified by the applicant.

**48. Precautions against leakage before connection -** (1) The supplier shall not connect with his works the installation or apparatus on the premises of any applicant for supply unless he is reasonably satisfied that the connection will not, at the time of making the connection, cause a leakage from that installation or apparatus exceeding one-five thousandth part of the maximum current supplied to the applicant's premises.

(2) If the supplier declines to make a connection under the provisions of sub-rule (1), he shall serve upon the applicant a notice in writing stating his reason for so declining.

**49. Leakage on consumer's premises.**(1) If the Inspector or the supplier has reason to believe that there is in the system of a consumer leakage which is likely to affect injuriously the use of energy by the supplier or by other persons, or which is likely to cause danger, he may give the consumer reasonable notice in writing that he desires to inspect and test the consumer's installation.

(2) If, on such notice being given -



- (a) The consumer does not give all reasonable facilities for inspection and testing of his installation, or
- (b) A leakage exceeding one-five-thousandth part of the maximum current supplied to the consumer's installation is shown to exist, the supplier may, and if directed so to do by the Inspector, shall discontinue the supply of the installation but only after giving to the consumer forty-eight hours' notice in writing of disconnection of supply and shall not re-commence the supply until the Inspector is satisfied that the cause of the leakage has been removed.

**50. Supply to consumers.**(1) The supplier shall not commence or continue to give supply of energy to any consumer unless –

- (a) a suitable linked switch or a circuit-breaker of requisite capacity to carry and break the current is placed as near as possible to, but after the point of commencement of supply as defined under rule 58, so as to be readily accessible and capable of being easily operated to completely isolate the supply to the installation, such equipment being in addition to any equipment installed for controlling individual circuits or apparatus.

Provided that where the point of commencement of supply and the consumer's apparatus are near each, one linked switch or circuit-breaker near the point of commencement of supply shall be considered sufficient for the purpose of this rule:

- (b) a suitable linked switch or circuit-breaker of requisite capacity to carry and break the full load current is inserted on the secondary side of a transformer, in the case of high or extra high voltage installation. Provided, however, that the linked switch on the primary side of the transformer may be such capacity as to carry the full load current and to break only the magnetism current of the transformer:

Provided further that the provision of this clause shall not apply to transformers installed in sub-stations up to and including 100KVA belonging to the supplier;

- (c) every distinct circuit is protected against excess energy by means of a suitable cut-out or a circuit breaker of adequate breaking capacity suitably located and so constructed as to prevent danger from over heating, arcing or scattering of hot metal when it comes into operating on and to permit of ready renewal of the fusible metal of the cutout without danger.
  - (d) the supply of energy to each motor or other apparatus is controlled by a suitable linked switch or a circuit breaker of requisite capacity placed in such a position as to be adjacent to the motor or other apparatus readily accessible to and easily operated by the person in charge and so connected in circuit that by its means all supply of energy can be cut off from the motor or apparatus, and from any regulating switch, resistance or other device associated therewith;
  - (e) all insulating material is chosen with special regard to the circumstances of its proposed use, the mechanical strength being sufficient for its purpose, and so far as is practicable, is of such a character or so protected as to maintain adequately its insulating properties under all working conditions in respect of temperature and moisture ; and
  - (f) adequate precautions are taken to ensure that no live parts are so exposed as to cause danger.
- (2) Every consumer or other user of energy shall so maintain his installation as to conform at all times to the provisions sub-rule (1), and shall use all reasonable means in his power to ensure that, where energy is supplied by a supplier, no person other than the supplier shall interfere with the service lines and apparatus placed by the supplier on his premises.

**51. Provisions applicable to medium high or extra-high voltage installations.** The following provisions shall be observed where energy at medium, high or extra high voltage is supplied, converted, transformed or used:-

- (1) (a) All conductors (other than those of overhead lines) shall be completely enclosed in mechanically strong metal casing or metallic covering which is electrically and

mechanically continuous and adequately protected against mechanical damage unless the said conductors are accessible only to an authorized person or are installed and protected to the satisfaction of the Inspector so as to prevent danger.

(b) All metal work enclosing, supporting or associated with the installation other than that designed to serve as a conductor shall if considered necessary by the Inspector, be connected with earth.

(c) Every main switch board shall comply with the following provisions, namely:-

- (i) a clear space of not less than 91.4 cm. in width shall be provided in front of the switchboard.
  - (ii) if there are any attachments or bare connections at the back of the, switchboard, the space (if any) behind the switchboard shall be either less than 22.86 cm. or more than 76.2 cm. in width, measured from the farthest outstanding part of any attachment or conductor;
  - (iii) if the space behind the switchboard exceeds 30 inches in width, there shall be a passage-way from either end of the switchboard clear to a height of 1.820 m.
- (2) Where an application has been made to a supplier for supply of energy to any installation, he shall not commence, or where the supply has been discontinued, recommence the supply unless he is satisfied that the consumer has complied in all respect with the conditions of supply set out in sub-rule (1) of this rules 50 and 64.
- (3) Where a supplier proposes to supply or use energy at medium voltage or to recommence supply after it has been discontinued for a period of six months, he shall, before connecting or reconnecting the supply, give notice in writing of such intention to the Inspector.
- (4) If at any time after connecting the supply the supplier is satisfied that any provision of sub-rule (1) of this rule, or of

rules 50 and 64 is not being observed, he shall give notice of the same in writing to the consumer and the Inspector specifying how the provision has not been observed and may discontinue the supply if the Inspector so directs.

**52. Appeal to Inspector in regard to defects** (1) If any applicant for a supply or a consumer is dissatisfied with the action of the supplier is declining to commence, to continue or to recommence the supply of energy to his premises on the grounds that the installation is defective or is likely to constitute danger, he may appeal to the Inspector to test the installation and the supplier shall not, if the inspector or, under his orders, any other officer appointed to assist the Inspector, is satisfied that the installation is free from the defect or danger complained of be entitled to refuse supply to the consumer on the grounds aforesaid, and shall, within twenty four hours after the receipt of such intimation from the Inspector, commence, continue or recommence the supply of energy.

(2) Any test for which application has been made under the provision of sub-rule (1) shall be carried out within seven days after the receipt of such application.

(3) This rule shall be endorsed on every notice given under the provisions of rules 37, 48 and 49.

**53. Cost of inspection and test of consumer's installation**

(1) The cost of the first inspection and test of a consumer's installation carried out in pursuance of the provisions of rule 47 shall be borne by the supplier and the cost of every subsequent inspection and test shall be borne by the consumer, unless in the appeal under rule 52, the Inspector directs otherwise.

(2) The cost of any inspection and test made by the Inspector, at the request of the consumer or other interested party shall be borne by the consumer or other interested party unless the Inspector directs otherwise.

- (3) The cost of each and every such inspection and test by whomsoever borne shall be calculated in accordance with the scale specified by the Central or the State Government as the case may be in this behalf.

**54. Declared voltage of supply to consumer.**

Except with the written consent of the consumer or with the previous sanction of the State Government a supplier shall not permit the voltage at the point of commencement of supply as defined under rule 58 to vary from the declared voltage by more than 5 per cent in the case of low or medium voltage or by more than 12½ percent in the case of high or extra-high voltage.

**55. Declared frequency of supply to consumer.**

Except with the written consent of the consumer or with the previous sanction of the State Government a supplier shall not permit the frequency of an alternating current supply to vary from the declared frequency by more than 3 percent.

**56. Sealing of meters and cut-outs** (1) A supplier must affix one or more seals to any cut-out and to any meter, maximum demand indicator or other apparatus placed upon a consumer's premises in accordance with section 26, and no person other than the supplier shall break any such seal.

- (2) The consumer shall use all reasonable means in his power to ensure that no such seal is broken otherwise than by the supplier.

- (3) The word 'supplier' shall for the purpose of this rule include a State Government when any meter, maximum demand indicator or other apparatus is placed upon a consumer's premises by such Government.

**57. Meters, maximum demand indicators and other apparatus on consumer's premises -** (1) Any meter or maximum demand

indicator or other apparatus placed upon a consumer's premises in accordance with section 26 shall be of appropriate capacity and shall be deemed to be correct if its limits of error do not exceed 3 percent, above or below absolute accuracy at all loads in excess of one-tenth of full load and up to full load.

- (2) No meter shall register at no load.
- (3) Every supplier shall provide and maintain in proper condition such suitable apparatus as may be prescribed or approved by the Inspector for the examination, testing and regulation of meters used or intended to be used in connection with the supply of energy.

Provided that the supplier may with the approval of the Inspector and shall, if required by the Inspector enter into a joint arrangement with any other supplier for the purpose aforesaid.

- (4) Every supplier shall examine, test and regulate all meters, maximum demand indicators and other apparatus for ascertaining the amount of energy supplied before their first installation at the consumer's premises and at such other intervals as may be directed by the State Government in this behalf.
- (5) Every supplier shall maintain a register of meters showing the date of a last test, the error recorded at the time of the test the limit of accuracy after adjustment and final test, the date of installation; withdrawal, reinstallation, etc., for the examination of the Inspector or his authorized representative.

**58. Point of commencement of supply.**

The point of commencement of supply of energy to a consumer shall be deemed to be the point at the outgoing terminals of the cut-outs inserted by the supplier in each conductor of every service line other than an earthed or earthed neutral conductor or the earthed external conductor of a concentric cable at the consumer's premises.

- 59. Precautions against failure of supply: Notice of failures** -(1)The lay-out of the electric supply lines of the supplier for the supply of the energy throughout his area of supply shall under normal working conditions be sectionalized and so arranged, and provided with cut-outs or circuit-breakers so located, as to restrict within

reasonable limits the extent of the portion of the system affected by any failure of supply.

- (2) The supplier shall take all reasonable precautions to avoid any accidental interruptions of supply, and also to avoid danger to the public or to any employee or authorized person when engaged on any operation during and in connection with the installation, extension, replacement, repair and maintenance of any works.
- (3) The supplier shall send to the Inspector notice of failure of supply of such kind as the Inspector may from time to time require to be notified to him, and such notice shall be sent by the earlier practicable post after the failure occurs or after the failure becomes known to the supplier and shall be in such form and contain such particulars as Inspector may from time to time specify.
- (4) For the purposes of testing or for any other purposes connected with the efficient working of the undertaking, the supply of energy may be discontinued by the supplier for such period as may be necessary subject (except in cases of emergency), to not less than twenty-four hours' notice being given by the supplier to all classes of consumers specified by the Inspector likely to be affected by such discontinuance and in the event of any consumer or consumers from such classes of consumers objected, the supply of energy shall not be discontinued (except in cases of emergency), without the consent of the Inspector and subject to such conditions as he may impose.

**60. Text for resistance of insulation** -(1) Where any electric supply line for use at low or medium voltage has been disconnected from a system for the purpose of addition or alteration or repair, such electric supply line shall not be reconnected to be system until the supplier or the owner has applied the test prescribed under rule 48.

- (2) The provision of sub-rule (1) shall not apply to overhead lines except overhead insulated cables unless the Inspector otherwise directs in any particular case.

**61. Connection with earth.** - (1) The following provisions shall apply to the connection with earth of systems at low voltage in cases where the voltage normally exceeds 125 volts and of systems at medium voltage.

- (a) The neutral conductor of a three-phase four-wire system, and the middle conductor of a two-phase three-wire system shall be earthed by not less than two separate and distinct connections with earth both at the generating station and at the sub-station. It may also be earthed at one or more points along the distribution system or service line in addition to any connection with earth which may be at consumer's premises.
- (b) In the case of a system comprising electric supply lines having concentric cables, the external conductor of such cables shall be earthed by two separate and distinct connections with earth.
- (c) The connection with earth may include a link by means of which the connection may temporarily interrupted for the purpose of testing or for locating a fault.
- (d) (i) In a direct current three-wire system the middle conductor shall be earthed at the generating station only, and the current from the middle conductor to earth shall be continuously recorded by means of a recording ammeter, and if at any time the current exceeds one-thousandth part of the maximum supply current, immediate steps shall be taken to improve the insulation of the system.
- (ii) Where the middle conductor is earthed by means of a circuit-breaker with a resistance connected in parallel, the resistance shall not exceed 10 ohms and on the opening of the circuit-breaker immediate steps shall be taken to improve the insulation of the system, and the circuit breaker shall be reclosed as soon as possible.



- (e) In the case of an alternating current system, there shall not be inserted in the connections, with earth any impedance (other than that required solely for the operation of switch-gear or instruments), cut-out or circuit breaker, and the result of any test made to ascertain whether the current (if any) passing through the connection with earth is normal, shall be duly recorded by the supplier.
- (f) No person shall make connection with earth by the aid of, nor shall be keep it in contact with any water main not belonging to him except with the consent of the owner thereof and of the Inspector.
- (g) Alternating current systems which are connected with earth as aforesaid may be electrically interconnected.

Provided that each connection with earth is bonded to the metal sheathing and metallic armouring (if and) of the electric supply lines concerned.

- (2) The frame of every generator, stationary motor, and so far as is practicable, portable motor, and the metallic parts (not intended as conductor) of all transformers and any other apparatus used for regulating or controlling energy and all medium voltage energy consuming apparatus shall be earthed by the owner by two separate and distinct connections with earth.
- (3) All metal casings or metallic coverings containing or protecting any electric supply line or apparatus shall be connected with earth and shall be so joined and connected across all junction boxes and other opening as to make good mechanical and electrical connection throughout their whole length:

Provided that where the supply is at low voltage, this sub-rule shall not apply to isolated wall tubes or to brackets, switches, fans, regulator covers or other fittings (other than portable hand lamps and portable and transportable apparatus unless provided with earth terminal.

This sub-rule shall come into force immediately in the case of new installation and in case of existing installations the provisions of this sub-rule shall be complied with before the expiry of a period of two years from the commencement of those rules.

- (4) All earthing systems shall, before electric supply lines or apparatus are energized, be tested for electrical resistance to ensure efficient earthing.
- (5) All earthing systems belonging to the supplier shall, in addition, be tested for resistance on dry day during the dry season not less than once every two years.
- (6) A record of every earth test made and the earth thereof shall be kept by the supplier for a period of not less than two years after the day of testing and shall be available to the Inspector when required.

**62. System of medium voltage.**

Where a medium voltage supply system is employed, the voltage between earth and any conductor forming part of the said systems shall not, under normal conditions, exceed low voltage.

- 63. Approval by Inspector.-** (1) Before making an application to the Inspector for permission to commence supply of energy at high or extra-high voltage to any person, the supplier shall ensure that the high or extra high voltage electric supply lines or apparatus belonging to him are placed in position, properly joined and duly completed and examined. The supply of energy shall not be commenced by the supplier unless and until the Inspector is satisfied that the provisions of rules 65 to 69 both inclusive have been complied with and the approval in writing of the Inspector has been obtained by him.

Provided that the supplier may energise the aforesaid electric supply lines or apparatus for the purpose of tests specified in rule 65.

- (2) The owner of any high or extra-high voltage installation shall, before making application to the Inspector for approval of his installation or additions thereto, test every high or

extra-high voltage circuit or additions thereto, other than an overhead line, and satisfy himself that they withstand the application of the testing voltage set out in sub-rule 65 and shall duly record the results of such tests and forward them to the Inspector:

Provided that, an Inspector may direct such owner to carry out such tests as he deems necessary or if he thinks fit, accept the manufacturer's certified test in respect of any particular apparatus in place of the tests required by this sub-rule.

- (3) The owner of any high or extra-high voltage installation who makes any additions or alterations to his installation shall not connect to the supply his apparatus or electric supply lines comprising the said alterations or additions unless and until such alterations or additions have been approved in writing by the Inspector.

**64. Use of energy at high or extra-high voltage.** -(1) The Inspector shall not authorize a supplier to connect a supply of energy at high or extra-high voltage to any consumer, unless:-

- (a) all conductors and apparatus intended for use at high or extra-high voltage and situated on the premises of the consumer are inaccessible except to authorized person and all operations in connection with the said conductors and apparatus are carried out only by an authorized person;
- (b) the consumer has provided and agrees to maintain a separate building or a locked weather-proof and fireproof enclosure of agreed design and location, to which the supplier shall at all times have access, for the purpose of housing his high or extra-high voltage apparatus and metering equipment, or where the provision of a separate building or enclosure is impracticable, the consumer has segregated the aforesaid apparatus of the supplier from any other part of his own apparatus.

Provided that such segregation shall be by the provision fire-proof walls, if the Inspector considers it to be necessary.

Provided further that in the case of an out-door installation the consumer shall suitably segregate the aforesaid apparatus belonging to the supplier from his own to the satisfaction of the Inspector.

- (c) all pole type sub-stations are constructed and maintained in accordance with rule 69.
- (2) The following provisions shall be observed where energy at high or extra high voltage is supplied, converted, transformed or used
  - (a) all conductors or live parts of any apparatus shall ordinarily be inaccessible.
  - (b) All windings, at high or extra-high voltage of motors or other apparatus within reach from any position in which a person may require to be, shall be suitably protected so as to prevent danger.
  - (c) Where transformer or transformers are used, suitable provision shall be made, either by connecting with earth a point of the circuit at the lower voltage or otherwise, to guard against danger by reason of the said circuit becoming accidentally charged above its normal voltage by leakage from or contact with the circuit at the higher voltage.
  - (d) (i) Where a sub-station or a switch-station is situated in any building and where fire in the sub-station or switch station might involve risk to the said building and the said sub-station or switch-station contains oil-immersed transformers, switches or static condensers involving the use of more than 500 gallons (2,270.5 liters) of oil in one chamber, provision shall be made for suitable oil soak-pit and where use of more than 2,000 gallons (9,082 liters) of oil in any one oil-tank, receptacle or chamber is involved, provision shall be made for the draining away or removal of any oil which may leak or escape from the tanks, receptacles or chambers containing the same; special precautions shall be taken to prevent the spread of any fire resulting from the ignition of the oil from any cause and adequate provision

shall be made for extinguishing any fire which may occur. Spare oil shall not be stored in any such sub-station or switch-station..

- (ii) Cable trenches inside sub-stations and switch-stations containing cables shall be filled with sand, pebbles or similar non-inflammable materials or completely covered with non-inflammable slabs.
- (e) Unless the conditions are such that all the conductors and apparatus for use at high or extra-high voltage may be made dead at the same time for the purpose of cleaning or for other work thereon, the said conductor and apparatus shall be so arranged that they may be made dead in sections, and that work on any section made dead may be carried on by an authorized person without danger.
- (f) Adequate precautions shall be taken to prevent unauthorized access to any part of the installation designed to be electrically charged at high or extra high voltage.

**65. Voltage tests.** – (1) High and extra-high voltage electric supply-lines (other than overhead lines) and apparatus of the supplier shall not be connected to a system for the purposes of supply or use of energy unless the insulation of the said electric supply-lines and apparatus has withstood, either –

- (i) the tests prescribed in that behalf in the appropriate specification of the Indian Standards Institution or in its absence the British Standards Institution then current ; or
- (ii) in cases where no such tests have been prescribed, the continuous application, between conductors and also between conductors and earth during a period of one minute of the testing voltage given in sub-rule (2)

(2) For the purposes of clause (ii) of sub-rule (1) –

- (a) if the normal working voltage does not exceed 1,000 volts, the testing voltage shall be 2,000 volts ;
- (b) if the normal working voltage exceeds 1,000 volts, but does not exceed 11,900 volts, the testing voltage shall be double the normal working voltage ;

- (c) if the normal working voltage exceeds 11,000 volts, the testing voltage shall be normal working voltage plus 10,000 volts ;

Provided that an apparatus which is not new shall be tested in such a manner as the Inspector may specify.

- (3) If the test prescribed in sub rule (1) is made prior to the said electric supply-lines and apparatus being placed in position for the purposes of supply of energy, the said electric supply-lines and the apparatus after having been placed in position and before being connected to the system shall have withstood a further test for resistance of insulation either by the application of the tests prescribed in sub-rule (1) whenever reasonably practicable, or by the application of a testing voltage of not less than 1,000 volts either alternating current or direct current between conductors and also between conductors and earth during a period of not less than one minute.
- (4) Where any electric supply line (other than an overhead line) or apparatus for use at high or extra-high voltage has been disconnected from a system for alteration or repair, such electric supply line or apparatus shall not be reconnected to the system until the supplier has applied the test prescribed in sub rule (3) and satisfied himself that the insulation of the electric supply line or apparatus is in sound condition.
- (5) The supplier shall duly record the result of every test made under this rule.
- (6) Notwithstanding the provisions of sub-rules (1) to 94), (both inclusive) the Inspector may, where he thinks fit, accept the manufacturer's certified tests in place of the tests prescribed in this rule.

**66. Metal sheathed electric supply lines : Precautions against excess leakage** - (1) The following provisions shall apply to electric supply lines {other than overhead-lines} of a supplier for use a high or extra-high voltage :-

- (a) The conductors shall be enclosed in metal sheathing which shall be electrically continuous and connected with earth, and the conductivity of the metal sheathing shall be maintained and reasonable precautions taken where necessary to avoid corrosion of the sheathing.
- (b) In the event of a failure of insulation occurring between one conductor and the metal sheathing at any point along an electric supply line as aforesaid, the impedance of the relevant circuit shall be such that, with the full voltage maintained at the source of supply, the current resulting from such failure shall not be less than twice the value of the current for which a suitable cut out of adequate rupturing capacity or other suitable over load protective device has been set to operate or the current required to operate a suitable discriminative fault current relay:

Provided that the operation of the aforesaid overload protective device or of the discriminative fault current relay shall cause the automatic operation of a circuit-breaker of adequate rupturing capacity.

The relevant circuit hereinbefore referred to means the complete circuit from the source of supply to the point of failure of the insulation, including any connection with earth of the system of which the electric supply line as aforesaid forms part and any current-limiting device inserted in such connection with earth ; and the source of supply means the point at which energy is given to the system or circuit of which the electric supply line as aforesaid forms part.

- (c) Where an electric supply-line as aforesaid has concentric cables and the external conductor is insulated from an outer metal sheathing and connected with earth, the external conductor may be regarded as the metal sheathing for the

purposes of this rule, provided that the foregoing provisions as the conductivity are complied with.

- (2) Nothing in the provisions of sub-rule (1) shall preclude the employment in generating stations, sub-stations and switch-stations (including outdoor sub-stations and outdoor switch-stations) of conductors for use as high or extra-high voltages which are not enclosed in metal sheathing or preclude the use of electric supply lines laid before the prescribed date to which the provisions of these rules apply.

**67. Connection with earth.** – (1) The following provisions shall apply to the connection with earth of three-phase systems for use at high or extra-high voltages :-

In the case of star-connected systems with earthed neutrals or delta connected systems with earthed artificial neutral point :

- (a) the neutral point shall be earthed by not less than two separate and distinct connections with earth each having its own electrode at the generating station and at the sub-station and may be earthed at any other point, provided that no interference of any description is caused by such earthing;
  - (b) in the event of an appreciable harmonic current flowing in the neutral connections so as to cause interference with communication circuits, the generator or transformer neutral shall be earthed through a suitable impedance.
- (2) Single-phase high or extra-high voltage systems shall be earthed in a manner approved by the Inspector.
  - (3) In the case of system comprising electric supply lines having concentric cables, the external conductor shall be the one to be connected with earth.
  - (4) Where a supplier proposes to connect with earth an existing system for use at high or extra-high voltage which has not hitherto been so connected with earth, he shall give not less



than fourteen days' notice in writing together with particulars to the telegraph authority of the proposed connection with earth.

- (5) Where the earthing lead and earth connection are used only in connection with earthing guards erected under high or extra-high voltage overhead lines where they cross a telecommunication line or a railway line, and where such lines are equipped with earth leakage relays of a type and setting approved by the Inspector, the resistance shall not exceed 25 ohms.
- (6) In so far as the provisions of rule 61 are consistent with the provisions of this rule, all connections with earth shall also comply with the provisions of that rule.

**71. Additional provision for supply to high voltage luminous tube sign installations** – (1) any person who proposes to use or who is using energy for the purpose of operating a luminous tube sign installation, or who proposes to transform or who is transforming energy to a high voltage for any such purpose shall comply with the following conditions:-

- (a) All live parts of the installation including all apparatus and live conductors in the secondary circuit, but excluding the tubes except in the neighborhood of their terminals shall be inaccessible to unauthorized persons and such parts shall be effectively screened.
- (b) Irrespective of the method of obtaining the voltage of the circuit which feeds the luminous discharge tube sign, no part of any conductor of such circuit shall be in metallic connection (except in respect of its connection with earth) with any conductor of the supply system or with the primary winding of the transformer.
- (c) All live parts of an exterior installation shall be so disposed as to protect them against the effects of the weather, and such installation shall be so arranged and separated from its surroundings as to limit, as far as possible, the spreading of fire.

- (d) The secondary circuit shall be permanently earthed at the transformer and the core of every transformer shall be earthed.
- (e) Where the conductor of the primary circuit are not in metallic connection with the supply conductors (e.g., where a motor-generator or a double-wound convertor is used), one phase of such primary circuit shall be permanently earthed at the motor-generator or convertor, or at the transformer.
- (f) a final sub-circuit which forms the primary circuit of a fixed luminous-discharge-tube sign installation shall be reserved solely for such purpose.
- (g) A separate primary final sub-circuit shall be provided for each transformer or each group of transformers having an aggregate input not exceeding 1000 volt amperes, of a fixed luminous discharged-tube sign installation.
- (h) An interior installation shall be provided with suitable adjacent means for disconnecting all phases of the supply except the "neutral" in a three phase four-wire circuit.
- (j) For installations on the exterior of a building a suitable emergency fire-proof linked switch to operate on all phases except the neutral in a three-phase four-wire circuit shall be provided and fixed in a conspicuous position at not more than 9 ft. above the ground.
- (k) A special "caution" notice shall be affixed in conspicuous place on the door of every high voltage enclosure to the effect that the high voltage supply must be cut off before the enclosure is opened.
- (l) Where static condensers are used, they shall be installed on the load side of the fuses and the primary (low voltage) site of the transformer.
- (m) Where static condensers are used on primary side, means shall be provided for automatically discharging the condensers when the supply is cut off:

Provided that static condensers or any circuit interrupting devices on the high or extra-high voltage side shall not be used without the approval in writing of the Inspector.

- (2) The owner or user of any luminous tube sign or similar high voltage installation shall not bring the same into use without giving to the Inspector not less than 14 day's notice in writing of his intention so to do.

**77. Clearance above ground of the lowest conductor** - (1) No conductor of an overhead line, including service lines, erected across a street shall at any part thereof be at a height less than -

(a) for low and medium voltage lines ... 19 ft (5.791 m)

(b) for high voltage lines ... 20 ft (6.096 m)

(2) No conductor of an overhead line, including service lines, erected along any street shall at any part thereof be at a height less than -

(a) for low and medium voltage lines ... 18 ft (5.484 m)

(b) for high voltage lines ... 19 ft (5.791 m)

(3) No conductor of an overhead line, including service lines, erected elsewhere than along or across any street shall be at a height less than -

(a) for low, medium and high voltage lines  
Up to and including 11,000 volts, if bare ... 15 ft (4.472 m)

(b) for low, medium and high voltage lines  
Up to and including 11,000 volts,  
if insulated ... 13 ft (3.962 m)

(c) for high voltage lines above 11,000 volts ... 17 ft (5.182 m)

(4) For extra-high voltage lines the clearance above ground shall not be less than 17 ft. plus 1 foot (0.3048 m.) for every

33,000 volts or part thereof by which the voltage of the line exceed 33,000 volts:

Provided that the minimum clearance along or across any street shall not be less than 20 feet (6.096 m.)

**79. Clearance from buildings of low and medium voltage lines and service liens** - (1) Where a low or a medium voltage overhead line passes above or adjacent to or terminates on any building, the following minimum clearances, from any accessible point on the basis of maximum sag, shall be observed.

(a) for any flat roof, open balcony, verandah roof and lean to roof -

(i) when the line passes above the building a vertical clearance of 8 feet (2.439 m.) from the highest point, and

(ii) when the line passes adjacent to the building a horizontal clearance of 4 feet (1.219 m.) from the nearest point, and

(b) for pitched roof -

(i) when the line passes above the building a vertical clearance of 8 feet (2.439 m.) immediately under the lines and -

(ii) when the line passes adjacent to the building a horizontal clearance of 4 feet (1.219 m.)

(2) any conductor so situated as to have a clearance less than that specified in sub-rule (1) shall be adequately insulated and shall be attached by means of metal clips at suitable intervals to a bare earthed bearer wire having a breaking strength of not less than 700 (317.45 kg.) lbs.

(3) The horizontal clearance shall be measured which the line is at a maximum deflection from the vertical due to wind pressure.

**80. Clearance from buildings of high and extra-high voltage lines** -

(1) Where a high or extra high voltage overhead line passes above or

adjacent to any building or part of a building it shall have on the basis of maximum sag a vertical clearance above the highest part of the building immediately under such line, of not less than -

- (a) for high voltage lines up to and including 33,000 volts 12 ft. (3.658 m.)
- (b) for extra-high voltage line 12 ft. (3.658 m.)  
Plus 1 foot (0.3048 m.) for every additional 33,000 volts or part thereof.

(2) The horizontal clearance between the nearest conductor and any part of such building shall on the basis of maximum deflection due to wind pressure, be not less than -

- (a) for high voltage lines up to and including 11,000 volts ... 4 ft (1.219 m)
- (b) for high voltage lines above 11,000 volts And up to and including 33,000 volts ... 6 ft (1.829 m)
- (c) for extra-high voltage lines ... 6 ft (1.829 m)  
Plus 1 foot (0.3048 m) every addition 33,000 volts or part thereof.

**85. Maximum intervals between supports** - All conductors shall be attached to supports at interval not exceeding the safe limits based on the ultimate tensile strength of the conductors and the factor of safety prescribed in rule 76;

Provided that in case of overhead lines carrying low or medium voltage conductors, when erected in, over, along or across any street, the intervals shall not, without the content in writing of the Inspector, exceed 220 feet.

**86. Conditions to apply where telecommunication lines and power lines are carried on same supports** : - Every overhead telecommunication line erected on supports carrying a power lines

shall consist of conductors each having a breaking strength of not less than 600 lbs. (272.10 kg)

- (2) Every telephone used on a telecommunication line erected on supports carrying a power line shall be suitably guarded against lighting and shall be protected by cut-outs.
- (3) Where a telecommunication line is erected on supports carrying high or extra-high voltage power line arrangement shall be made to safeguard any person using the telephone against injury resulting from contact, leakage or induction between such power and telecommunication lines.

**87. Lines crossing or approaching each other.** - (1) Where an overhead line crosses or is in proximity to any telecommunication line, the owner of the overhead line shall protect it in a manner laid down in the Code of Practice of the Power and Telecommunication Co-ordination Committee.

- (2) When it is intended to erect a telecommunication line which will cross or be in proximity to an overhead line the person, proposing to erect such telecommunication line shall give notice in writing of his Intention to the owner of the overhead line and the owner of the overhead line shall, within twenty-one days of receiving such notice provide the protection referred to in sub-rule (1).
- (3) Where an overhead line crossed or is in proximity to an overhead line belonging to another person, the owner of the line which was last erected shall so protect it as to guard against the possibility of its coming into contact with the other overhead line.
- (4) A person erecting or proposing to erect an overhead line may require the owner of the overhead line to provide the protection referred to in sub-rule (3) within twenty-one days of the receipt of the notice in that behalf.
- (5) In all cases referred to in the preceding sub-rules, the expenses of making the guarding arrangement shall be borne by person whose line was last erected.

- (6) Where two line cross, the crossing shall be made as nearly at right angle as the nature of the case admits.
- (7) The guarding arrangement shall ordinarily be carried out by the owner of the support on which it is made and he shall be responsible for its efficient maintenance.
- (8) All work required to be done by or this rule shall be carried out to the satisfaction of the Inspector.

**88. Guarding** - (1) Where guarding is required under these rules the provisions of sub-rules (2) to (4) shall apply.

- (2) Every guard -wire shall be connected with earth at each point at which its electrical continuity is broken.
- (3) Every guard-wire shall has an actual breaking strength of not less than 1,400 lbs. (634.90 kg) and if made of iron or steel, shall be galvanized.
- (4) Every guard-wire or cross-connected system of guard-wires, shall have sufficient current-carrying capacity to ensure the rendering dead without risk of fusing of the guard-wire till or wire the contact of any live wire has been removed.
- (5) Lines crossing trolley-wires - In the case of a crossing over a trolley wire the guarding shall fulfill the following conditions, namely:
  - (a) where there is only one trolley-wire, two guard-wires shall be erected as in diagram A;
  - (b) where there are two trolley-wires and the distance between them does not exceed 15 inches (38.1 cm. two guard-wires shall be erected as in diagram B;
  - (c) where there are two trolley-wires and the distance between them exceeds 15 inches (38.1 cm.) but does not exceed 48 inches or 1.219 m. three guard-wires shall be erected as in diagram C;
  - (d) where there are two trolley-wires and the distance between them exceeds 48 inches (1.219 m.) each trolley-wire shall be separately guarded as in diagram D;

- (e) the rise of the trolley boom shall be so limited that if the trolley leaves the trolley-wire, it shall not foul the guard-wires ; and
- (f) where a telegraph-line is liable to fall or be blow down upon an arm, stay-wire, guard hooks shall be provided to prevent such sliding.

**89. Service-lines from overhead liens:** - No service-line or tapping shall be taken off an over-head line except at point of support.

**90. Earthing** - (1) All metal support of overhead lien and metallic fittings attached thereto, shall be permanently and efficiently earthed. For this purpose a continuous earth wire shall be provided and securely fastened to each pole and connected with ordinarily at four point in every mile or 1.601 km. the spacing between the points being as nearly equidistant as possible. Alternatively, each support and metallic fitting attached thereto shall be efficiently earthed.

- (2) Each stay-wire shall be similarly earthed unless an insulator has been placed in at a height not less than 10 ft. from the ground.

**91. Safety and protective devices :-** (1) Every overhead line (not being suspended from a dead bearer wire not being covered with insulating material and not being a trolley-wire erected over any part of a street or other public place or in any factory or mine or on any consumer's premises shall be protected with a device approved by the Inspector for rendering the line electrically harmless in case it breaks.

- (2) An Inspector may by notice in writing require the owner of any such overhead lines wherever it may be erected to protect it in the manner specified in sub-rule (1)
- (3) The owner of very high and extra-high voltage over head line shall make adequate arrangements to the satisfactions of the Inspector to prevent unauthorized person from ascending any of the supports of such overhead lines without the aid of a ladder or special appliances.



**92. Protection against lightning** – (1) The owner of every overhead line which is so exposed as to be injury from lightning shall adopt efficient means for diverting to earth any electrical surges due to lightning.

(2) The earthing lead for any lightning arrestor shall not pass through any iron or steel pipe, but shall be taken as directly as possible from the lightning-arrestor to a separate earth electrode subject to the avoidance of bends wherever practicable.

**93. Unused overhead line:-** (1) Where an overhead line ceases to be used again electric supply line, the owner shall maintain it in an a safe mechanical condition in accordance with rule 76 or shall remove it.

(2) Where any overhead line ceases to be used as an electric supply-line, an Inspector may, by a notice in writing served on the owner, require him to maintain it in a safe mechanical condition or to remove it within fifteen days of the receipt of the notice.

## **Electrical Installation:**

Important of electric power plant:

- Cheap and abundant supply of electric power is the major factor in the development of country. It is used in industrial organization, domestic purpose, defense, agricultural production etc.
- Modern life is so much dependent upon electric power that the power capital consumption of electricity is the index of the economic development, property and standard of living of a nation.
- As power system increased in size, so did the number transmission lines, transforms, switch gear, protection devices and soon and their expectation also become make complex and challenging.

Component of power system:

An electric power system is constituted of several sub-systems broadly an electric power system can be divided into the following system.

- i) Generation system.
- ii) Transmission system.
- iii) Sub-transmission system.
- iv) Distribution system.
- v) Protection and control system.

- i) Generation system.

This system is constituted of groups of generating stations, check the connection of energy from the primary energy source in one form into electrical energy takes place in electrical generating through the process of electromagnetic energy conversion.

- ii) Transmission system.

The overhead transmission network transfer electrical energy from generating stations located at various locations usually over long distances, to the distribution system from where it is distributed.

- iii) Sub-transmission system.

It is the portion of the transmission system that connect the high voltage substations through step down transformers to the distribution sub-stations.

- iv) Distribution system:

Distribution is the process by which energy is fed locally to various distribution sub-station in feeders those are fed from one or more main transmission substations.

A distribution substation is constituted of overhead distribution lines and underground cables and its function is to supply quality power to consumers.

- v) Protection and control system:

This system is constituted of relays, switchgear, and other control devices that protect the various systems against faults and overhead and ensure efficient, reliable and economical operation of the electric power system.

#### **Source of electrical energy:**

By source of energy are meant material objects that contain energy usable quantities. In its mutually transformable forms, energy is conventionally classified into such forms as chemically, mechanical, electrical, nuclear etc.

Energy resources are classified in the following ways:

- 1) Based on usability of energy.

- a) Primary Resources:

Resources available in nature in raw form are called primary energy resources, e.g. fossil fuel (coal, oil and uranium, hydro-electric power plant etc.) Generally this form of energy can not be used directly.

- b) Intermediate Resources:  
This is obtained from primary energy by one or more steps of transformation and is used as a source of energy.
- c) Secondary Resources:  
This form of energy which is finally supplied to consumer for utilization is known as secondary or usual energy e.g. electrical energy, thermal energy, chemical energy etc.
- 2) Based on traditional use.
  - a) Conventional: (fossil fuels, nuclear and hydro resources)
  - b) Non conventional (wind, solar)
- 3) Based on long term availability;
  - a) Non-renewable:  
Resources, which are finite and do not get replenish after, their consumption are caused non-renewable, e.g. fossil fuel, uranium etc.
  - b) Renewable:  
Resources, which are renewed by nature again and again and their supply is not affected by the rate of their consumption are caused renewable e.g. solar, wind, bio mass, ocean, geothermal, hydro etc.
- 4) Based on origin:
  - a) Fossil fuel energy.
  - b) Nuclear energy.
  - c) Hydro energy
  - d) Solar energy.
  - e) Wind energy.
  - f) Biomass energy.
  - g) Geothermal energy.
  - h) Tidal energy.
  - i) Ocean thermal energy.
  - j) Ocean wave energy.
- 5) Based on commercial application:
  - a) Commercial energy resources  
The secondary usable energy resources form such as fossil fuel (coal, oil, natural gas), hydro or nuclear fuel etc. are essential for commercial production and are categories as commercial energy resource.
  - b) Non commercial energy  
The energy derived from nature and used directly without planning through commercial outlet is called non-commercial resource e.g. wood, animal dung cake, crop residue etc.

**Conventional and non conventional method of electric power generation:**

Conventional:

- Energy resources, which have been traditionally used for many decades and were in common used around oil crises of 1973 are caused conventional energy resources e.g. fossil fuels, nuclear and hydro resources.

Non-conventional:

- Energy resources, which are considered for longer use after the oil crises of 1973 are caused non conventional energy resources e.g. solar, wind, bio mass etc.
- Conventional source except hydro are non-renewable and would finish one day.
- Conventional sources (fossil fuel, nuclear) also caused pollution. Due to this reason it has become independent resource and developed non-conventional energy resource to reduced much dependence on conventional resources.

**Advantage of conventional energy sources:**

- i) Cost - At present it is cheap.
- ii) Security - by saving such quantity the energy availability can be ensured for a certain extra period.
- iii) Convenience - It is very convenient to us.

## **HOUSE WIRING**

As the wiring system in any electrical building is essential for use of power in any building or complex it involves all the requirements of safety, durability, cost and appearance. It is as per the requirement of different type of consumers. According to the capability and requirement of the consumer and also according to the site of use of electricity, the wiring system of different client adopted.

Following points should be kept by mind before selecting a wiring for the site:

- 1) Durability:  
The wiring selected and the materials used in it likes wires etc. should have a long life and should not easily affected by the weather changes.
- 2) Safety:  
Wiring should be done by a perfect electrician and there should not be any danger of leakage for shock.
- 3) Cost:  
The system chosen should be economical to suit the owner of building and initial cost of wiring within the capacity of individual.
- 4) Accessibility:  
In the wiring system the facility for expansion for renewal should be provided.

- 5) **Appearance:**  
Wiring appearance has its own effect. Architectural point should be kept in need.
- 6) **Mechanical Protection:**  
The wiring should be protected for damaged of physical nature during its use in house and factory.

### **TYPES OF WIRING**

Basing on above, the wiring is divided into following types in general.

- 1) Cleat wiring.
- 2) Wooden casing and capping wiring.
- 3) Cab tier sheathed or top rubber sheathed wiring.
- 4) Lead sheathed wiring.
- 5) Conduit wiring.

### **Cleat Wiring:**

As per the name indicates, cleat wiring is named after the material used to hold the wiring, is known as cleat. Cleat is made of porcelain materials. The general types of cleats are of two grooved and three grooved. The cleat used is of two parts. One part is bottom and other one is top. Both bottom and top part are so grooved that they are capable of holding the wires in the groove. The cleat is placed on the wall surface in which the wires are supported. The arrangement of wiring is either vertical or horizontal. The cleats are fixed on the surface of the help of wooden plugs (popularly called as gutties) in horizontal system the distance between cleats are 60 cm and in vertical system 30 cm maximum. This wiring is generally implied for normal supply of 250V. it is so arranged that the interval between the wires is maintained 4 cm for sub and main and 2.5 cm in case of branch load and point loads. The cables / wires run inside the cleats should not be very tight to avoid damage of insulation. Also there should be no crossness. The wires and cables in this wiring system are recommended of ISI marked and may be of PVE cables, VIR cables and any other approved insulation.

This is a purely temporary type of wiring

It is popularly used for electrical installation for temporary sites where it is remove and materials easily collected for other works. The situation of

such types are Programme Pendants, Construction Site Offices, Camp Offices, Business Camps, Exhibition and like.

#### Advantages:

Advantages of cleat wirings are as follows:

- 1) The installation and dismantling is easy and quick.
- 2) The type of labour required is unskilled electrician.
- 3) Cleat wiring can be installed on damp walls.
- 4) For short period.
- 5) Addition alteration and inspection of this type of wiring is easy.
- 6) It is cheap.

#### Disadvantages:

- 1) It is subjected to mechanical injury as the wires are exposed.
- 2) It is not good looking which is a great disadvantage.
- 3) Its life is shorter.
- 4) As the wire is exposed to atmosphere, the insulation catches dampness from the atmosphere and a common salt is formed and deposited on the surface of the wires. As a result the life of the wires degraded. The resistance of the insulation decreases in short period, so there is chance of leakage of current after passing of time.

#### Precautions:

- 1) All wooden fitting i.e. blocks, boards etc. use in this wiring system should be of well seasoned tick wood. Now a days may be of hard plastic.
- 2) The wires in this system can be installed near structural work, gas pipe, water pipe and similar harmful situation.
- 3) While passing through wall conduits are to be used and wooden busting are to be used to close the terminals of the conduit.
- 4) The recommended interval between cleats should not be increase. Sharp bends must be avoided. While making bends a continuous cure shall be preferred. Proper type of cleat shall be selected for number of wires for running. In no case two or more wires shall be

- placed in one slot of the cleats. Wherever necessary number of cleats be increased.
- 5) While erecting wires, care shall be taken to stretch the wires, so that they neither touch the wall nor between themselves.
  - 6) When the wirings do cross each other, a bridge shall be formed to keep the wires separated from each other.

### **CTS wiring:**

In this wiring system CTS i.e. cab tyre sheathed wires are used. Now a days PVC wires are used in place of CTS wires. The CTS wires are available in single core. two Core or three core with a circular or oval shape. The wires are fixed on the well seasoned. Wooden batten by means of clips these are of two types.

- 1) Batten should be made of well seasoned teak wood and be painted and varnished.
- 2) The size of wire should not be less than 1.50 mm<sup>2</sup>.
- 3) There should not be any tension on the wires.
- 4) The distance between the gauties should not be more than 50 cm.
- 5) Do not give right angle bend to wires.
- 6) All the metallic parts and sockets should be earthed.
- 7) While crossing the wires bridges should be used.
- 8) Batten joint should be prepared according to requirement.

Table -1.  
Showing Number of wires which can be carried over  
a particular size of batten.

Size of batton (Width xThickness)	Number and size of link clip required	Number of wires of size 1/1.40mm dia, single core, aluminium conductor that can be laid
13mmx13mm	1x38mm	2
19mmx13mm	1x50mm	3

25mm x 13mm	2x38mm	4
31mm x 13mm	1x38 mm and 1x50mm	5
37mm x 13mm	3x38mm	6
44mm x 13mm	2x38mm and 1x50mm	7
50mm x 13mm	1x38mm and 2x50mm	8
56mm x 13mm	3x50mm	9
61mm x 13mm	2x38mm and 2x50mm	10
67mm x 13mm	1x38mm and 3x50mm	11
75mm x13mm	4x50mm	12

Advantages:

- This type of wiring can be done in damp place.
- It has long life.
- Its general appearance is good.
- It requires less labour and therefore is less costly.
- It requires less space.

Disadvantages:

- It cannot be done at those place where it is eposed to sun and rain.
- It cannot be done at those place where chemical fumes are present such as battery charging rooms etc.

**Wooden Casing and Capping Wiring:**

As the name implies the wires or cables used for wiring system are held inside the wooden casing and covered by wooden capping. The wires are not visible in this type. So, this wiring gives a very good looking.

In this type of wiring seasoned knot free tick woods are used in which the grooves free are made to accommodate the single core wires. However, as he cost of the tick woods as gone very high such types of wiring are not used in general. Even in this age it is rarely seen. As it is good



looking, now a days it is being substituted by use of PVC casing capping where it is preferred to install on a good looking wiring.

The groove made in the casing is generally of 'U' shaped and of two parallel grooves. The grooves accommodate the PVC, VIR or other recommended ISI marked wires. The casing is placed on the surface by the help of gutties and screws. For long lines joints are made for one piece to another as shown in the figure. Bridges, Tee joints, Right angle joints are made to cross the wiring or change the direction of the wiring as per requirement.

Table-2.  
Size of wood Casing and Capping

Width of Casing or Capping	mm	38	44	51	64	76	89	102
No. of grooves		2	2	2	2	2	2	2
Width of grooves	mm	6	6	9	13	16	16	19
Width of dividing fillet	mm	12	12	15	18	24	35	38
Thickness of outer wall	mm	7	10	10	10	10	11	13
Thickness of casing	mm	16	16	19	19	25	32	32
Thickness of capping	mm	6	6	10	10	13	13	13
Thickness at the back under groove	mm	6	6	6	10	10	10	13
Length available	mts	From 2.5 to 3.0 metres						

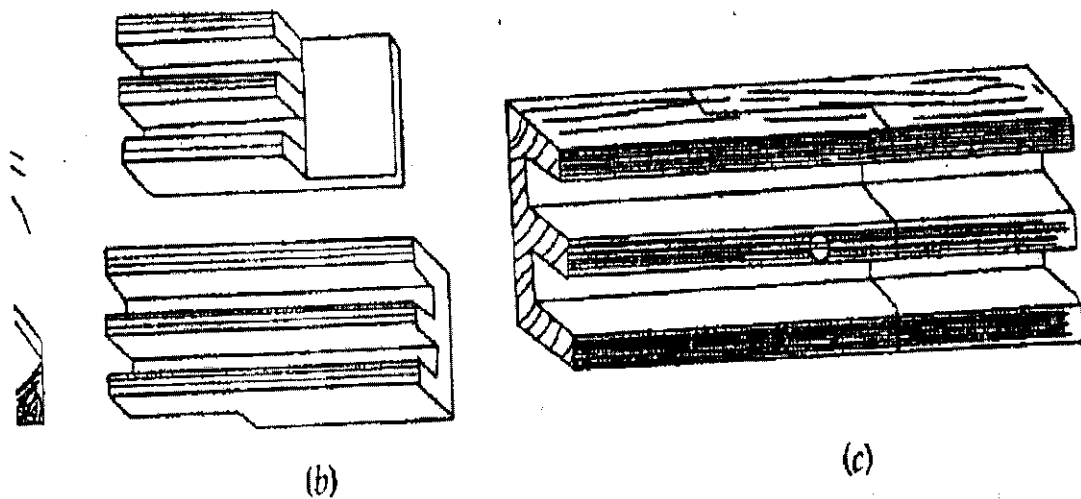

Fig.(II):2.10. Straight joint

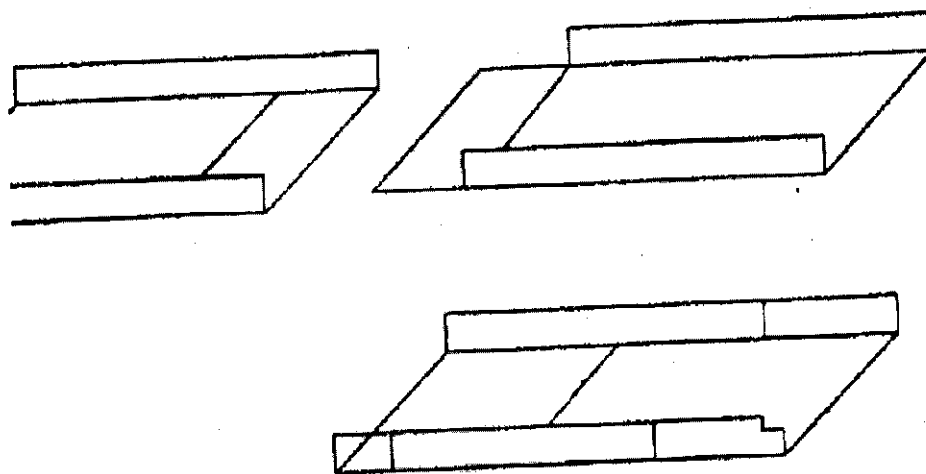

Fig.(II):2.11 Straight joint of PVC channel.

Methods of fixing of casing on wall and ceiling:

Important considerations of following are taken care while fixing the casing on wall and ceiling.

- i) This type of wiring shall be installed on drywalls. It is always avoided to burry under the plaster of wall.
- ii) Care must be taken to avoid for fixing in proximate to gas, water pipe and steam.

- iii) Cares shall be taken while fixing the casing on wall surface such that the cross screws are in the same plane of the casing surface by making countersunk.
- iv) According to the requirement of number of wires to run inside the casing the width of the casing varies. While fixing the casing the interval between the screws that holed the casing should not be more than 60 cm up to a size of 64 mm. For more than 64 mm casing it can be at a distance of 90 cm maximum.
- v) As per the parallel groove, one groove while carrying phase wires the other groove should carry neutral wires means the opposite polarity of current carrying wires shall not be in same groove.

Table-3

Number of Aluminium conductor, PVC insulated cables that may be drawn in one groove of the casing.

Size of Wire No & dia in mm	Material of conductor	No. of cables that can be laid in one groove of casing of size						
		38mm x 16mm	44mm x 16mm	51mm x 19mm	64mm x 19mm	76mm x 25mm	89mm x 32mm	102mm x 32mm
1/1.40	AL	1	1	2	4	8	12	15
1/1.80	AL	1	1	2	3	6	10	12
1/2.24	AL	...	...	2	2	5	8	10
1/2.80	AL	...	...	1	1	4	6	8
1/3.55	AL	...	...	1	1	3	5	6
7/1.70	AL	...	...	...	...	1	2	4
7/2.24	AL	...	...	...	...	1	1	2
7/2.50	AL	...	...	...	...	1	1	1
7/3.00	AL	...	...	...	...	1	1	1
19/1.80	AL	...	...	...	...	1	1	1

- vi) The size of the capping covering the casing shall be of same width and the distance between successive screws holding the capping is limited to 30 cm in case of casing not exceeding 64 mm. For higher sizes above 64 mm and 3 grooved casing, the interval between screws holding capping is extended to 45 cm.

vii) Gaps between the joints and gaps between the casing and wall shall be avoided. Grooves must be rounded off and sharp corners are avoided at the bends to prevent damages to the insulation of the cables. Care is taken to prepare better layout for minimizing the crossing of conductors inside the capping and wherever necessary bridges are formed for cross lines.

Advantages:

- It has good appearance.
- The wires are shape from atmosphere.
- The phase and neutral wires can easily be detected.
- The life is sufficiently long.

Disadvantages:

- There is a risk of fire.
- It can be easily affected by the moisture.
- Fault location is not easily point out
- Extension of wiring is not easy
- To make the joints very smooth and clean, skilled labours are required. It means the cost would increase.

## **Conduit Wiring:**

This system of wiring is used for domestic installation and workshops it provides mechanical protection and safety against fire. This wiring is of two types:

- a) Surface conduit wiring.
- b) Concealed conduit wiring.

### **a) Surface conduit wiring:**

This type of wiring is done after the completion of the building. The conduit pipes are fixed to the surface of wall or ceiling by means of saddles. These saddles are fixed to the wooden gaulties at an interval not more than one meter. However, where conduit are joined by a conduit socket, bend or Tees fitting, saddles are fixed at distance of 30 cm from centre of such fitting. In long running of pipe the junction boxes are provided at a sufficient distance to facilitate the provision of wires etc. Burrs are formed inside the conduit pipe while cutting it. If these Burrs are not removed, that can damaged the insulation of the wires. wooden bush or PVC bush are inserted inside the conduit and later the wires are pulled through by their steel wire system.

Table- 4

**Table showing number of wires that can be accommodated in the conduit of size as shown against each for wires of VIR or PVC insulated both copper and Al conductors.**

No. and Diameter of wire in mm	Nominal x sectional area in mm <sup>2</sup>	Material of conductor	No. of wires that can be accommodated in conduit of size											
			20mm		25mm		30mm		38mm		50mm		60mm	
			S	B	S	B	S	B	S	B	S	B	S	B
1/1.12	1.0	copper	7	5	13	10	20	14	-	-	-	-	-	-
3/0.736	1.25	copper	7	5	12	10	20	14	-	-	-	-	-	-
1/1.40	1.5	Al	7	5	12	10	18	12	-	-	-	-	-	-
3/0.925	2.0	Copper	5	4	10	8	18	12	-	-	-	-	-	-
1/1.80	2.5	Al	6	5	10	8	16	10	-	-	-	-	-	-
7/0.736	3.0	copper	5	4	8	6	12	10	-	-	-	-	-	-
1/2.24	4.0	Al	4	3	7	6	12	10	-	-	-	-	-	-
7/0.925	4.5	copper	3	2	6	5	10	8	-	-	-	-	-	-
1/2.80	6.0	Al	3	2	6	5	10	8	-	-	-	-	-	-
7/1.12	6.75	copper	2	-	5	4	8	7	-	-	-	-	-	-
1/3.55	10	Al	2	-	5	4	8	7	-	-	-	-	-	-
7/1.32	12	copper	-	-	4	3	6	5	8	6	-	-	-	-
7/1.626	14	copper	-	-	3	2	4	4	7	6	-	-	-	-
7/1.70	16	Al	-	-	2	-	4	3	7	6	-	-	-	-
19/1.12	18	copper	-	-	-	-	4	3	6	5	10	7	12	8
7/2.24	25	Al	-	-	-	-	3	2	5	4	8	6	9	7
19/1.32	30	copper	-	-	-	-	3	2	5	4	8	6	9	7
7/2.50	35	Al	-	-	-	-	2	-	4	3	7	5	8	6
19/1.626	40	copper	-	-	-	-	-	-	3	3	6	5	8	6
7/3.00	50	Al	-	-	-	-	-	-	4	3	6	4	6	5
19/1.80	50	copper	-	-	-	-	-	-	2	-	5	4	6	5

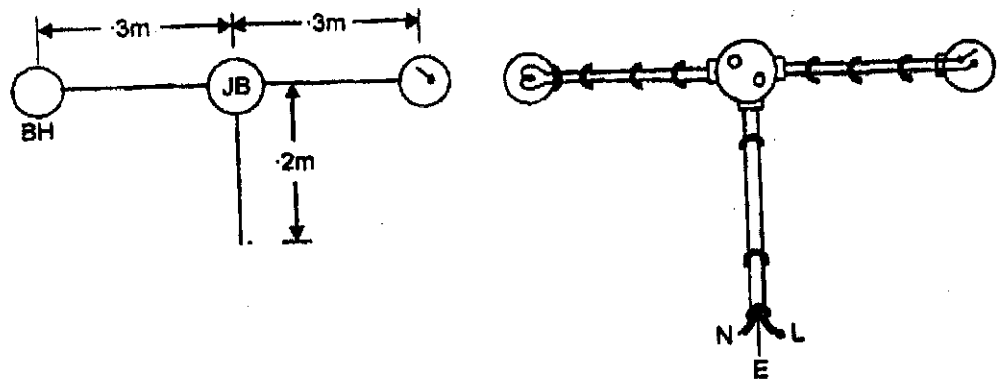

Fig.[II]:248. Showing conduit wiring

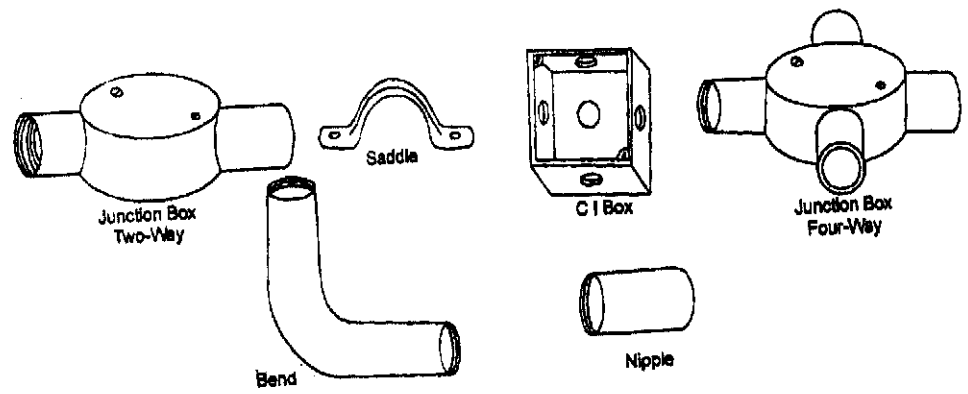
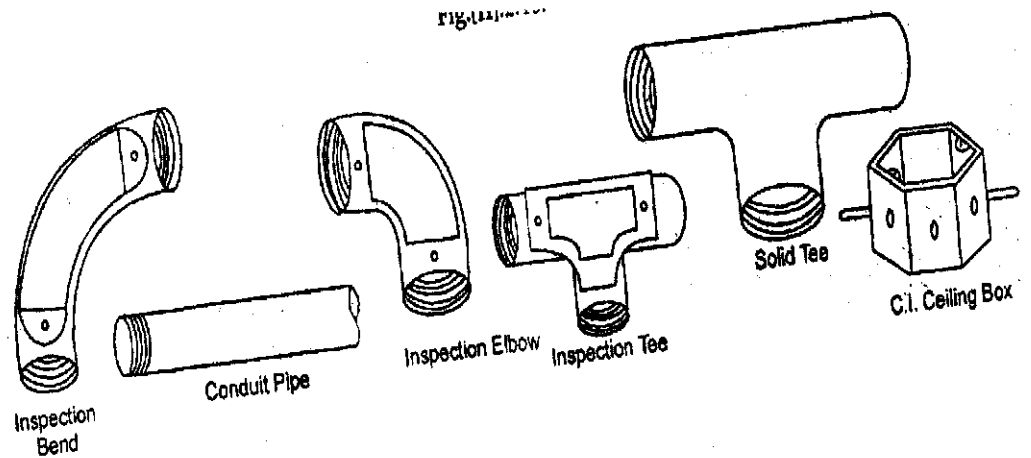

Fig.[II]:247. Conduit Accessories.



Advantages:

- The wiring can be done in open places.
- The cost of their system is less.
- There is no risk of fire.

Disadvantages:

- Its general appearance is not good.

**b) Concealed conduit wiring:**

This type of wiring is done at the time of the construction of the building. First the channels are formed in the wall, ceiling etc. The conduit pipe are fixed in thru channels by means of pipe hooks or shadle at interval not more than 60 cm. Suitable inspection type conduit accessories like junction boxes, Tee, elbow etc. are provided. After the fixing of the conduit pipes in the channels there are closed and the wall is plastered.

Table-5

NUMBER OF PVC/VIR AL WIRES THAT CAN RUN IN A CONDUIT

Size of conductor	Cross-sectional Area	20mm	25mm	32mm	40mm
1/1.40 mm	1.50	7	12	16	-
1/1.80 mm	2.50	6	10	14	-
1/2.24 mm	4.0	4	7	12	-
1/2.80 mm	6.0	2	5	8	-
1/3.55 mm	10.0	-	5	7	-
7/1.70 mm	16	-	2	3	6
7/2.24 mm	25	-	-	3	4

Advantages:

- Its appearance is very good.

- It is fire proof.
- Its life is very long.
- The cable are safe from mechanical damage.
- Defective cable can be easily replaced.
- It can be done in any place.

**Table -6**  
**Comparison between various systems of wiring**

Sl. No.	Particulars	Cleat wiring	Wood casing Capping wiring	TRS wiring	Concealed conduit wiring
1	Cost	Very low	Medium	Low	Very costly
2	Voltage	Low (upto 250v)	Low (upto 250 v)	Low (upto 250 v)	Low or Medium upto 660v
3	Life	Very short	Fairly long	Long	Very long
4	Protection against fire	Poor	No	fair	Very good
5	Mechanical protection	No	Fairly good	good	Very good
6	Appearance	Not good	fair	good	Very good
7	Dampness Protection	None	poor	good	Fairly good
8	General reliability	poor	good	good	Very good
9	Type of labour required	Semi-skilled	Highly skilled	skilled	Highly skilled
10	Additions or alterations to the existing wiring	Very easy	Difficult	Easy	Most difficult
11	Field of applications	For temporary installations e.g. for functions marriages etc, buildings under constructions.	For residential commertial ,office buildings, Not preferred these days	Residential, commertial, office building and for general purpose.	For godowns workshops private and public building where economic factor does not apply.



## ACCESSORIES USED IN WIRING

Lighting Accessories available in the market

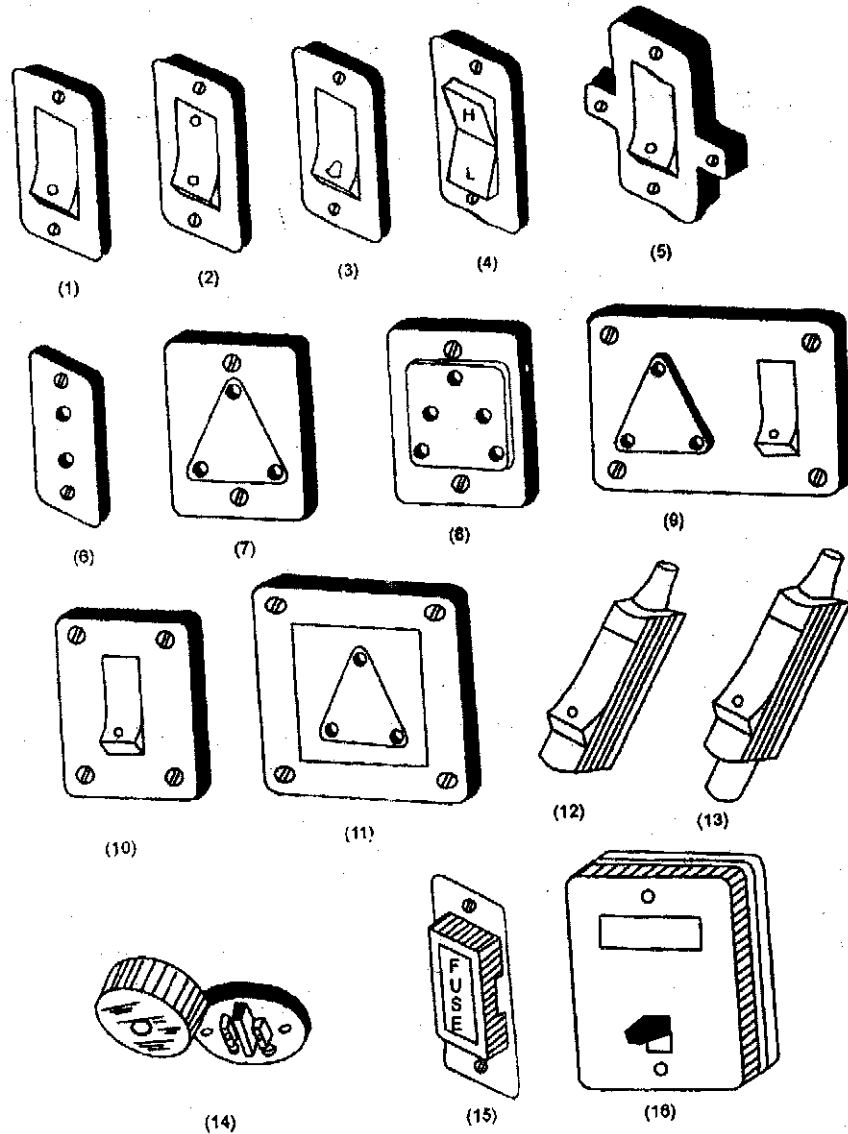

1. Tiny type 5 Amp. Switch. 2. Tiny type 5 Amp. Switch two way. 3. Tiny type 5 Amp. Switch three position. 4. Tiny type Switch S.P porcelain base. 5. 2 pin Tiny socket. 6. 3 pin Tiny type wall socket 5 Amp. 7. Universal Socket. 8. Tiny type Socket v. 9. Tiny type Switch 15 Amp. 10. 3 Pin tiny type wall socket 15 Amp. 11. Bed Switch. 12. Cord Switch. 13. Two plate ceiling rose flush type. 14. Tiny type kit kat 10 Amps. 15. main Switch.

Fig. III: 2.62

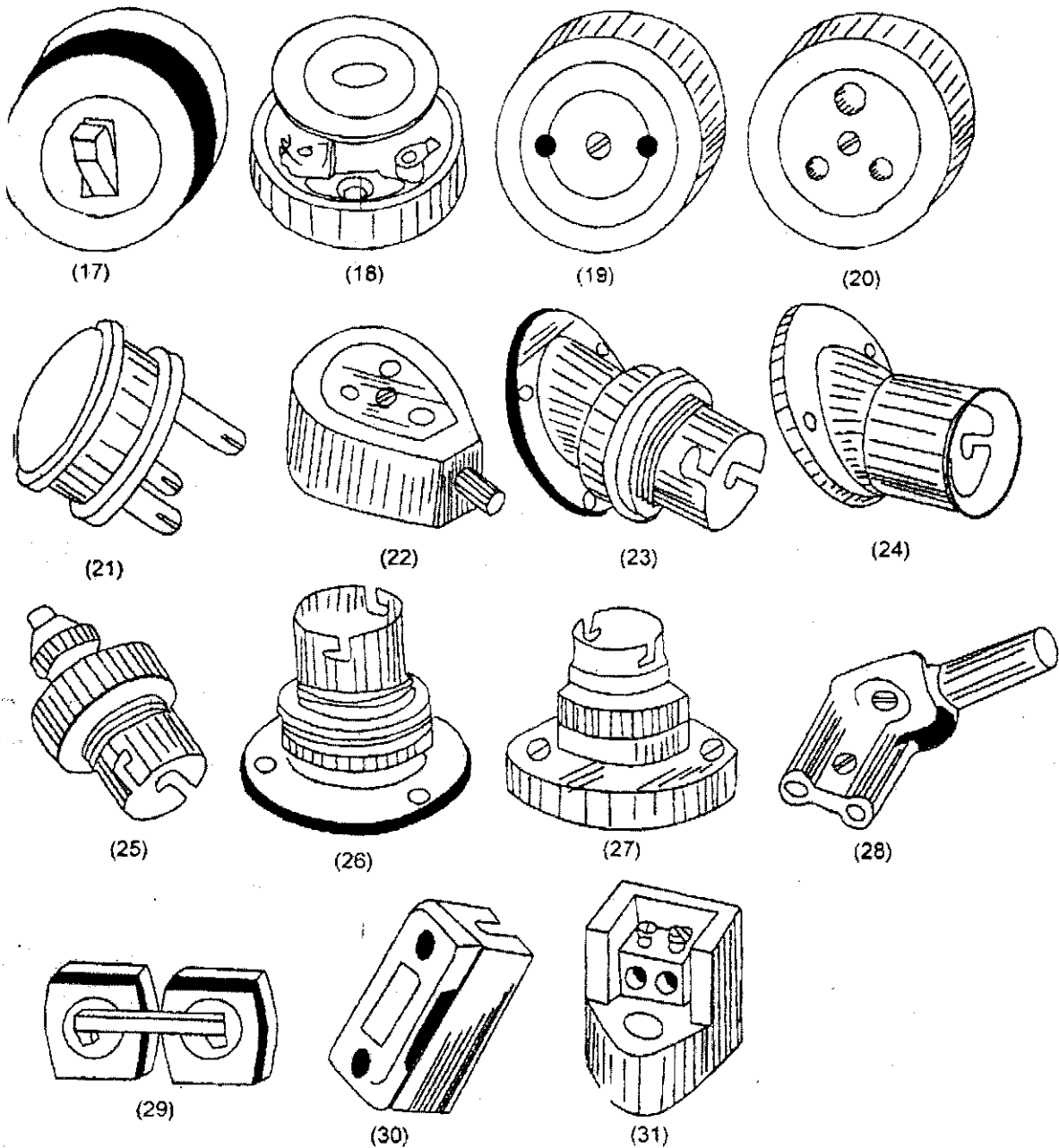

One way Tumbler Switch 5 A. 18. S. P. Flush type porc. base 5 A. 19. 2 pin Bakelite wall Socket 5 A. 20. 3 pin Bakelite wall Socket 5 A. 21. 3 pin Bakelite plug 5A. 22. 2 pin Switch Socket 5 A. 23. Angle polished brass lamp holder. 24. Angle bakelite lamp holder. 25. Pendant brass lamp holders. 26. Batten polished Brass lamp holder. 27. Batten bakelite lamp holder. Connector Bakelite. 29. Double pole Bakelite Switch porc. base. 30. Kit kat fuse 16 Amp. or 63 Amp. 240 V. 31. Neutral link 16A / 32A, 240 V.

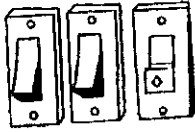

**5 A. Deluxe (Mini)**  
1-way Switch  
2-way Switch  
Mark Switch  
Push Switch

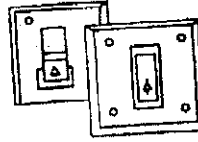

**5 A. Push Switch**  
Cliff Push Switch  
Royal Touch  
Push Switch

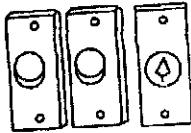

**5 A. Mini Finger Touch**  
1-way Switch  
2-way Switch  
Mark Switch  
Push Switch

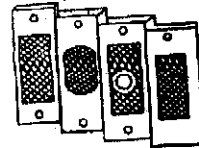

**5 A. Mini Indicator La**  
Mini Finger Touch  
Mini Deluxe/Delta  
Mini Dyna  
Mini Royal

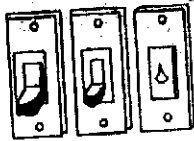

**5 A. Mini Classic**  
1-way Switch  
2-way Switch  
Mark Switch  
Push Switch

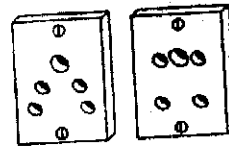

**5 A. Mini Socket**  
2-in Socket (5 Pin)  
Multi Socket  
For Fuse Two 2 Pin  
Top & One 3 Pin Top

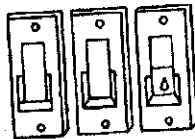

**5 A. Mini President**  
1-way Switch  
2-way Switch  
Mark Switch  
Push Switch

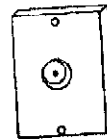

**Mini T.V. Antenna Socket**  
Mini T.V. Antenna  
Socket

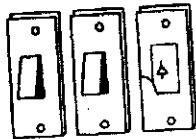

**5 A. Mini Dyna**  
1-way Switch  
2-way Switch  
Push Switch

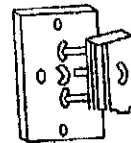

**Mini Telephone Socket**  
Telephone Socket with T  
Telephone Top Only  
Telephone Socket  
with Top & Box

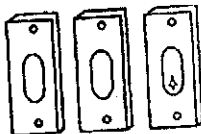

**5 A. Mini Piano**  
1-way Switch  
2-way Switch  
Push Switch

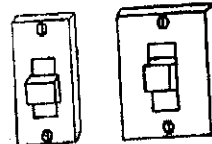

**Mini Kit Kat Fuse**  
Kit Kat Fuse 10 A  
Kit Kat Fuse 15 A

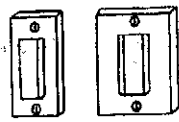

**Deluxe Kit Kat Fuse**

Fuse Unit 10 A

Fuse Unit 15 A

Fuse Knob Deluxe

Fuse Knob Mini

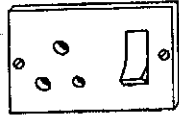

5 A. Switch Socket

Combined (Deluxe) Flush

3 Pin Switch & Socket

Switch & Socket

Procelain Base

3 Pin Switch & Socket

with Box



5 A. Switch Socket Combined

(Deluxe) Flush

2-in-1 Switch & Socket

2-in-1 Switch & Socket

with Box

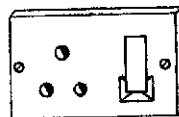

5 A. Switch Socket Combined

(President/Cliff)

3 Pin Switch & Socket

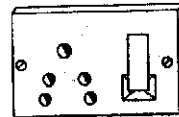

5 A. Switch Socket Combined

(President/Cliff)

2-in-1 Switch & Socket

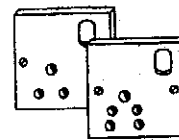

5 A. Switch Socket Combined

(Finger Touch) Flush

3 Pin Switch & Socket

with Indicator

2-in-1 Switch & Socket

With Indicator

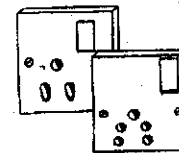

5 A. Switch Socket Combined

(Dyna) Flush

3 Pin Switch & Socket

with Indicator

2-in-1 switch & Socket

with Indicator

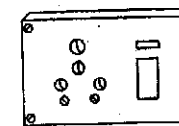

15 A. Switch Socket Combined

Universal Mini Caption

5 A. & 15 A. S/S Universal

5 A. & 15 A. S/S Universal

with box

5 A. & 15 A. Universal

Switch & Socket-Ind.

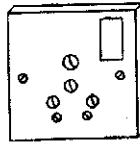

5 A and 15 A Dynaflush

15 A, Switch & Socket

Shutter & Indicator

5 A. & 15 A

Switch & Socket

Universal & Indicator

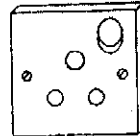

15 A, Switch Socket Combined

Finger Touch

15 A, Switch & Socket

with Shutter

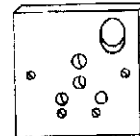

5 A, & 15 A, Switch Socket Combined

Universal (Finger Touch)

5 A & 15 A

Switch & Socket

(Universal)

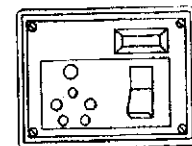

5-in-1 5 A. & 15 A

5-in-1

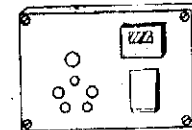

5-in-1 Deluxe Capton

5-in-1 deluxe Capton

with Box

Heavy Duty 5 A, & 15 A

Switch & Socket

Indicator & Fuse

Surface Mounting

Box (Silver) Silver (A)

Dimensions 86 x 30 mm

Deep 25 mm

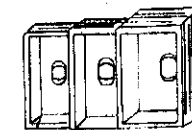

Silver (B)

Dimensions 86 x 40 mm

Deep 25 mm

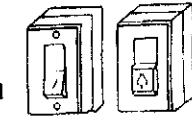

Silver (C)

Dimensions 86 x 50 mm

Deep 38 mm

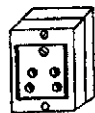

**5 A. Surface Deluxe**  
Switch  
1 Way Switch 2 Way Switch  
Push Switch

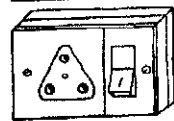

**5 A. Surface Deluxe**  
Socket  
2pin Socket  
3 Pin Socket

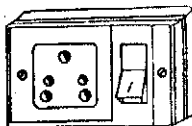

**5 A. Surface Deluxe Socket**  
2-in-1 Socket  
**5 A. Surface Deluxe S.S. Comb.**  
3 Pin Switch & Socket  
Combined

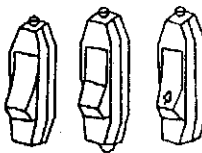

**5 A. Surface Deluxe S.S. Comb.**  
2-in-1 Switch & Socket  
Combined

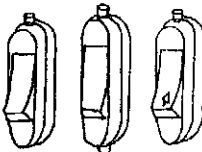

**Hang Cord Switches Pilot**  
Bed Switch-1-way  
Cord Through Switch  
Push Switch Hanging

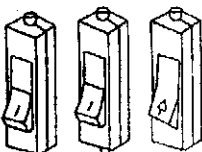

**Hang Cord Switches Deluxe**  
Bed Switch 1 Way  
Cord Through Switch  
Push Switch Hanging

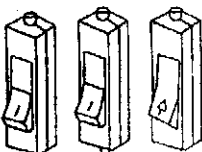

**Hang Cord Switches Dyna**  
Bed Switch 1 Way  
Cord Through Switch  
Push Switch Hanging

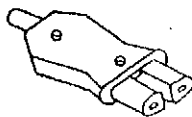

**15 A. Iron Connector**  
Procelain Base  
Iron Connector  
(Delux)  
Procelain Base Iron  
Connector (Dyna)

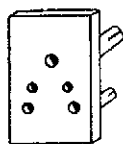

**5 A. 3 Pin Multi Plug Pilot**  
3 Pin Multiplug

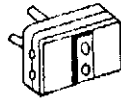

**5 A. Pin Multi Plug Deluxe**  
3 Pin Multi Plug. 5A.

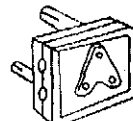

**5 A. 3. Pin Multi Plug Deluxe**  
3 Pin Multi Plug 5A.

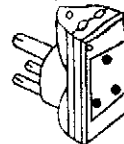

**15 A. 3 Pin Multi Plug.**  
3 Pin Multi Plug 15A.

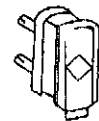

**5 A. 2 Pin Plug Top Recta**  
2 Pin Top Recta.



**5 A. 2 Pin Plug Top**  
2 Pin Top Gun Type

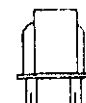

**5 A. 2 Pin plug Top Pilot**  
2 Pin Top Pilot

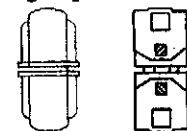

**5 A. Male Female**  
Male Female 5A. Pilot  
Male Female 5A. Dyna

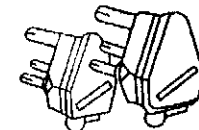

**3 Pin Plug Top**  
3 Pin Top 5A  
Trangle Deluxe  
3 Pin Top 15A.  
Triangle Deluxe

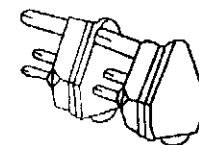

**3 Pin Plug Top**  
3 Pin Top 5A  
Unbreakable  
3 Pin Top 15A.  
Unbreakable

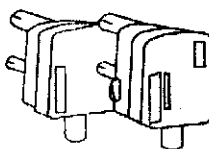

**15 A. Pin Plug Top**  
3 Pin Top 15A.  
Square Pilot  
3 Pin Top 15A.

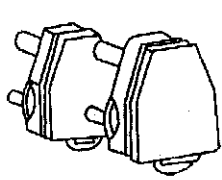

5 A. & 15 A. 3 Pin Plug Top (Dyna)  
3 Pin Top Dyna 5A  
3 Pin Top Dyna 15A

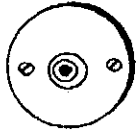

5 A. Ceiling Rose (Deluxe)  
Delux Flush Round

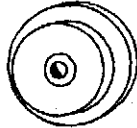

5 A. Ceiling Rose (Mini) Pilot  
Mini Surface 2 Plate  
Mini Surface 3 Plate



5 A. Ceiling Rose (Pilot)  
Pilot Surface 2 Plate  
Pilot Surface 3 Plate



5 A. Ceiling Rose (Anarkali)  
Anarkali Surface  
2 Plate  
Anarkali Surface  
3 Plate

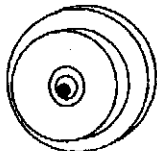

5 A. Ceiling Rose (Jumbo)  
Jumbo Surface 2 Plate  
Jumbo Surface 3 Plate

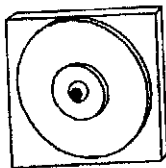

5 A. Ceiling Rose (Dyna)  
Dyna Square 2 Plate

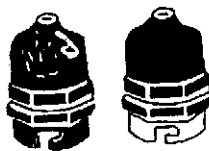

Pendent Holder Black  
Pendent Holder  
Black  
Pendent Holder  
Black O.B.R.

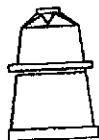

Pendent Holder Skirt  
Pendent Holder Skirt  
Pendent Holder  
Skirt O.B.R. W/G



Batten Holder  
Batten Holder Skirt  
O.B.R. BL/IV  
Batten Holder  
Skirt O.B.R. W/G  
Batten Holder President  
Batten Holder  
President (Big)

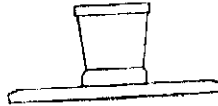

Angle Holder  
Angle Holder Skirt  
O.B.R. BL/IV  
Angle Holder  
Skirt O.B.R. W/G

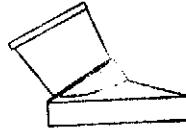

D.P. Switch (Pilot) Surface  
D.P. Switch Surface  
with Fuse Pilot  
D.P. Switch Surface  
Fuse & Indicator  
Pilot



D.P. Switch (Pilot) Flush  
D.P. Flush With Fuse  
Pilot  
D.P. Flush Fuse &  
Indicator Pilot

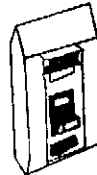

D.P. Surface Switch W/O Fuse  
D.P. Surface  
Without Fuse



15 A. Switch (Silver) Flush  
D.P. Silver Indicator  
W/O Fuse  
D.P. Mini with  
Indicator & Fuse

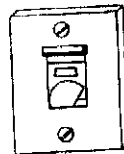

30 A. D.P. Switch (Recta) Flush  
D.P. Recta  
With Indicator  
30A Flush

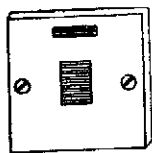

**15 A. D.P. Switch (Dyna) Flush**  
D.P. Dyna  
with Indicator  
15 A. Flush

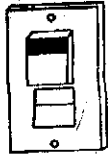

**D.P. Switch (Dyna King) Flush**  
D.P. Dyna King  
with Fuse Carrier



**D.P. Switch (Classic) Flush**  
D.P. Classic Flush  
with Fuse Carrier  
Indicator, Earthing  
30 A.



**T.P. (Tripple Pole)**  
T.P. (Tripple Pole)  
with Fuse  
30 A.



**Adaptor**  
Adaptor



**Strip Connector**  
5 A. Bakelite (12 Way)  
10 A. Bakelite (12 Way)  
15 A. Bakelite (12 Way)



**5 A. Surface Switch (Reno)**  
All Black  
1 Way Switch Round  
2 Way Switch Round



**5 A. Surface Switch (Reno)**  
Reno 1 Way Switch  
Porcelain Base Round  
Reno 2 way Switch  
Porcelain Base Round



**5 A. Surface Switch (Reno)**  
Rexa 1 Way Switch  
Porcelain Base  
Rexa 2 Way Switch  
Porcelain Base  
**5 A. Surface Switch (Hexa)**



Hexa 1 Way Switch  
Porcelain Base



**Hexa 2 Way Switch**  
Porcelain Base



**5 A. Surface Switch (Pilot)**  
Pilot 1 Way Switch  
Porcelain Base



Pilot 2 Way Switch  
Porcelain Base

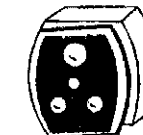

**5 A. Surface 2 Pin Socket**  
Reno 2 Pin Socket  
Round 5 A.



Reno 2 Pin Socket  
Porcelain Base 5 A



**5 A. Surface 3 Pin Socket (Reno)**  
Reno 3 Pin Socket 5 A  
Reno 3 Pin Socket  
Porcelain Base 5 A.



**5 A. Surface 3 Pin Socket (Reno)**  
3 Pin Socket  
Porcelain Base



**5 A. Surface Socket (Pilot)**  
Pilot 3 Pin Socket  
Porcelain Base 5 A.



**15 A. Surface Switch (Pilot)**  
Pilot 1 Way Switch  
15 A.



**15 A. Switch K-2**  
15 A. Switch  
with off-on  
indication

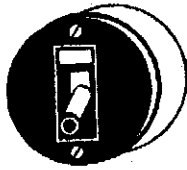

**15 A. Surface Switch (Reno)**  
Reno Round  
1-way Switch 15A

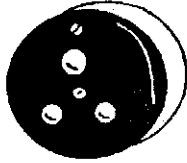

**15 A. Surface Socket (Reno)**  
3 Pin Socket  
Porcelain Base 15A.  
Round

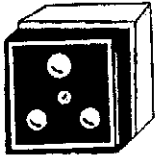

**15 A. Surface Socket (Pilot)**  
Pilot 3 Pin Socket  
Porcelain Base 15A.

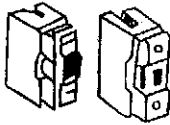

**Porcelain Kit Kat Fuse**  
16A. 240 V Supreme  
16A. 250 V Pilot

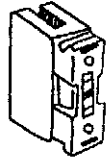

**Porcelain Kit Kat Fuse (Pilot)**  
16A—415V.  
Or 32 A — 240 V  
32 A — 415 V  
Or 63 A — 240

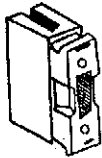

**Porcelain Kit Kat Fuse & With Indicator**  
16A—240 V & Indicator  
16A—415 V. & Indicator  
32 A—415. & Indicator



**Iron Clad Switch (Silver)**  
D.P.  
16A. — 240 V. Silver D.P.

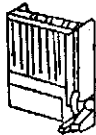

**Iron Clad Switch (Supreme)**  
D.P.  
16A—240 V Supreme

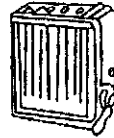

**Iron Clad Switches (Pilot)**  
D.P.  
16 A. 250 V. Pilot  
32 A. — 240 V.D.P.

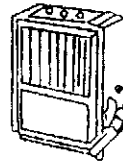

**Iron Clad Switches (Pilot)**  
T.P.  
16 A. — 415.T.P.  
32 A — 415 V. T.P.  
63 A. — 415 V.T.P.  
100 A — 415 V.T.P.

Gang Boxes are Made of Plastic and are Readymade Blocks in Which Flush Switches of Light or Power are Fixed

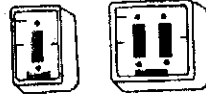

**Gang Box**  
Surface  
Ivory/Black  
1 Gang Box  
2 Gang Box

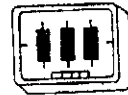

3 Gang Box

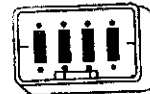

4 Gang Box Etc



**Gang Plate**  
1 Gang Plate  
2 Gang Plate

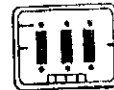

3 Gang Plate



4 Gang Plate Etc.

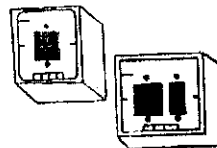

**Domestic Gang Box Surface**  
Ivory/Black  
1 Gang Domestic Box  
2 Gang Domestic Box

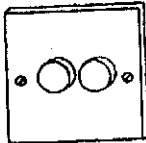

Table -7  
Selection chart of MCB's for household applications.

Appliance	Approximate Wattage at 230v A.C. Single phase	Current Rating of M.C.B	Type of MCB
1. Air conditioner	(a) 1 ton 1.5 kw Load upto 2.5 k.w load or one-ton	10 Amp 16 Amp	G-Series G-Series
	(b) 2 ton split unit upto 3.5 k.w	20 Amp	G-Series
2. Refrigerator	(a) 165 Litre	1.5 Amp	G-Series
	(b) 285 Litre	2.0 Amp	G-Series
3. Cooking Range			
(a) With oven cum griller	4500 watts	25 Amps	L-Series
(b) With oven cum griller	1750 watts	10 Amps	L-Series
(c) Oven only	750 watts	5 Amps	L-Series
4. Water Heater Geyser (Storage) Or Instant Geyser	1000 watts 2000watts 3000watts 6000watts	6Amps 10 Amps 15 Amps 30 Amps	L-Series L-Series L-Series L-Series
5. Electric Iron	750watts	5-Amps	L-Series
	1250watts	7.5 Amps	L-Series
6. Electric kettle	1500 watts	10 Amps	L-Series
7. Washing Machine With Heater	1500watts	10 Amps	G-Series
8. Room Heater	2000watts	10 Amps	L-Series



**Silver Flush Dimmer**  
Silver Flush 400 W.



**Recta Flush Dimmer**  
Recta 2 Gang 400 W  
Small



**Recta Flush Dimmer**  
Recta 2 Gang 800 W  
Big Etc.

Self made flush switches with plate (Plate Switch)

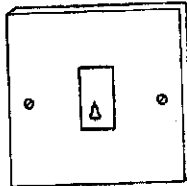

**5A. Switch**  
1 Push Switch

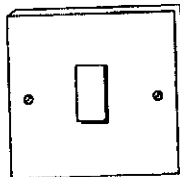
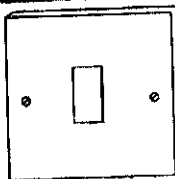

1-Switch One Way  
1-Switch Two Way

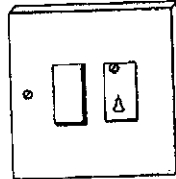
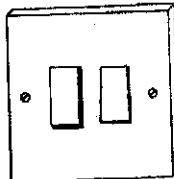

2-Switch Two Way  
1-Switch Two Way &  
1 Push Switch

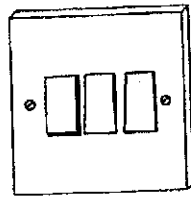
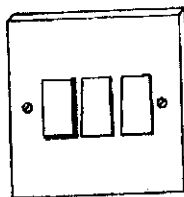

3-Switch Two Way  
2-Switch Two Way &  
1 Push Switch

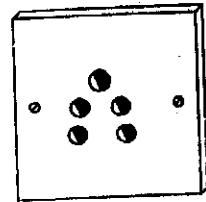
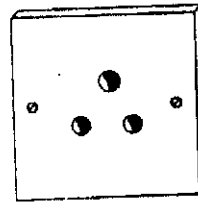

**5A. Switch & Socket**  
3 Pin Socket  
2-in-1 Socket

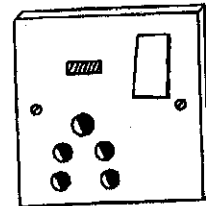
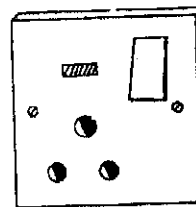

**5A. Universal**  
Switch Socket &  
Neon

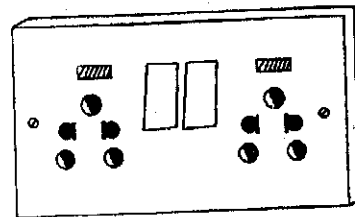

**5A. Double Switch**  
& Unisocket  
& Neon Etc.

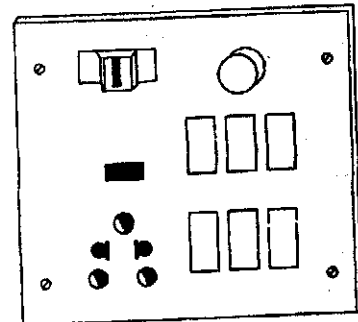

**Fuse Dimmer &**  
6 Switch & Socket  
Multi Purpose  
(Combination Unit)

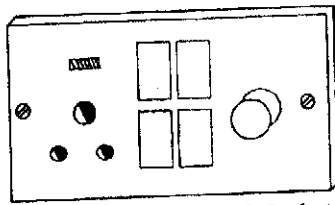

**Switch Socket & Dimmer**  
4 Switch  
3 Pin Socket  
With Shutter, Neon & Dimmer

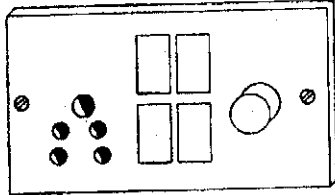

**4 Switch**  
Uni Socket, Neon  
& Dimmer Etc.

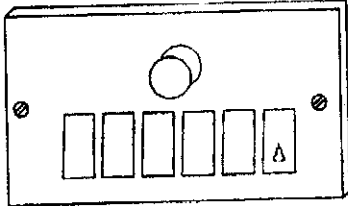

**5-Switch Two Way**  
& 1 Push Switch  
With Dimmer 400 W.

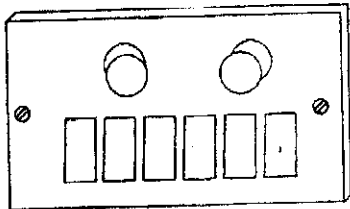

**6-Switch Two Way**  
& 2-dimmer 400 W. (Each)

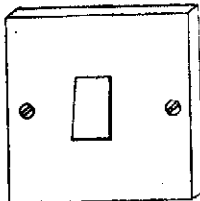

**15A Switch**  
Plate Type

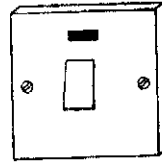

**15A. Switch & Neon**  
Plate Type

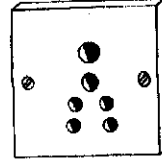

**5A. & 15A. Switch & Socket**  
5A & 15A Socket  
(Universal)

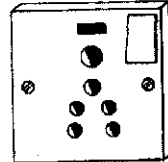

**5A. & 15 A**  
Switch Socket & Neon  
(Universal)

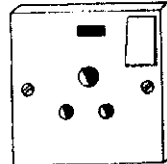

**15A. Switch Socket**  
With Shutter & Neon

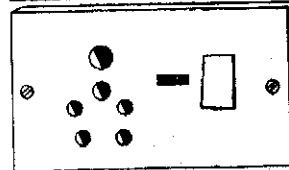

**5A. & 15A. Switch. Socket**  
& Neon (Big)  
Universal (King)

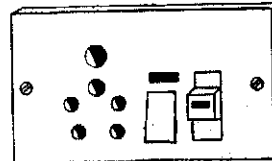

**400 W. Dimmer**  
800 W Dimmer  
400 W. 2-dimmer

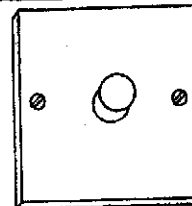
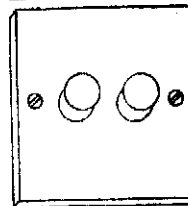

**5 x 15 A. Sockets.**  
Switch, Fuse & Neon  
Dyna Silver (5-in-1)  
5-in-1 with Box

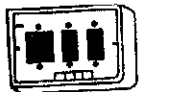

3 Gang Domestic Box



4 Gang Double Domestic Box

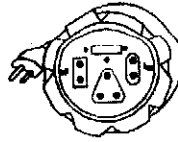

5 A. Extension Cord (Deluxe) With Indicator & Switch  
Deluxe Flexi Cord  
2 Pin (5 Meters)  
Deluxe Flexi Cord  
3 Pin (5 Metres)

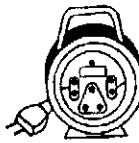

5 A. Extension Cord (2 Pin) With Indicator & Switch  
Flexi Cord  
(5 Meters) 2 Pin 5 A.  
Flexi Cord  
(10 Meters) 2 Pin 5 A

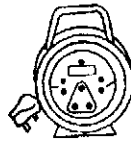

5 A. Extension Cord (3 Pin) With Indicator & Switch  
Flexi Cord  
(5 Meters) 3 Pin 5A  
Flexi Cord  
(10 Meters) 3 Pin 5A.

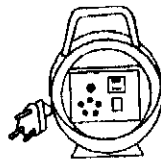

15 A. Extension Cord 5-in-1 Heavy Duty  
Flexi Cord 5-in-1  
(5 Meters) 15 A



Tube Holder  
Rotar Holder  
R-2 Pair  
Rotar Holder  
Bresspar Pair

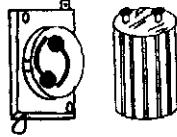

Starter Seat Starter  
Starter Seat R-2  
Starter Seat  
Ivory Brass Part  
Starter  
With Capacitor



Mercury Vapour Ballast  
80 W.M.V.  
125 W.M.V.  
250 W.M.V.  
400 W.M.V.  
1000 W.M.V.

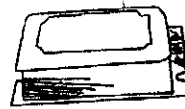

Fluorescent Ballast  
40 W/20 Shandar  
H.D. Ployester  
40 W/20 W Copper  
H.D. Ployester  
80 W.H.D. Ployester  
80 W. Copper H.D.  
Patti Fitting With  
Choke & Starter

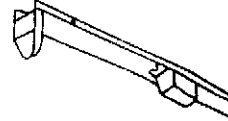

Patti 1220 M.M. (4)  
Stainless Steel  
Patti & Choke  
Patti 610 M. (2)  
Patti Copper Choke

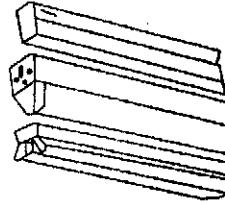

Box Type Fixture  
Box Type Fixture  
1200 M.M.  
Box Type  
Decorative Fixture

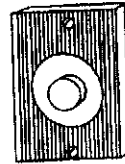

Electronic Solid State  
Dimmer/Regulator  
(Classic) Metallic Flush  
Metallic Flush 300 W.  
Metallic Flush 600 W.  
Metallic Flush 1000 W.

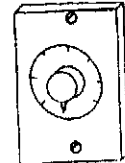

Classic Unbreakable Flush  
Unbreakable  
Flush 300 W.  
Unbreakable  
Flush 600 W.

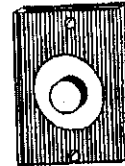

Classic Surface Dimmer  
Surface 300 W.

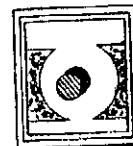

Supreme Flush Dimmer  
Dyna Metallic 400 W  
Supreme Plush 300 W  
Supreme Flush 600 W



Mini Flush Dimmer  
Switch Type 300 W.  
Mini Deluxe  
Socket Type 300 W.

Question  
 Prepare an estimate of materials for an electrical installation in CTS wiring system as per the load and plan given:

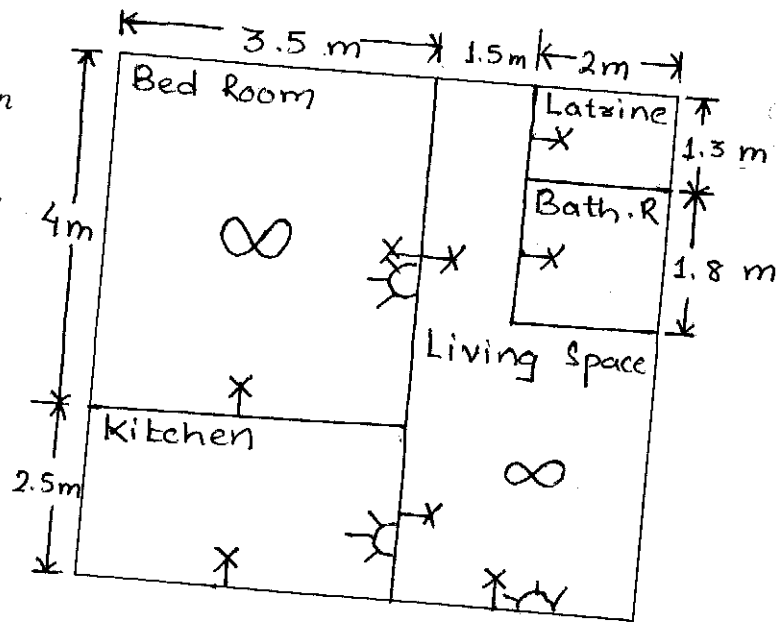

Solution:

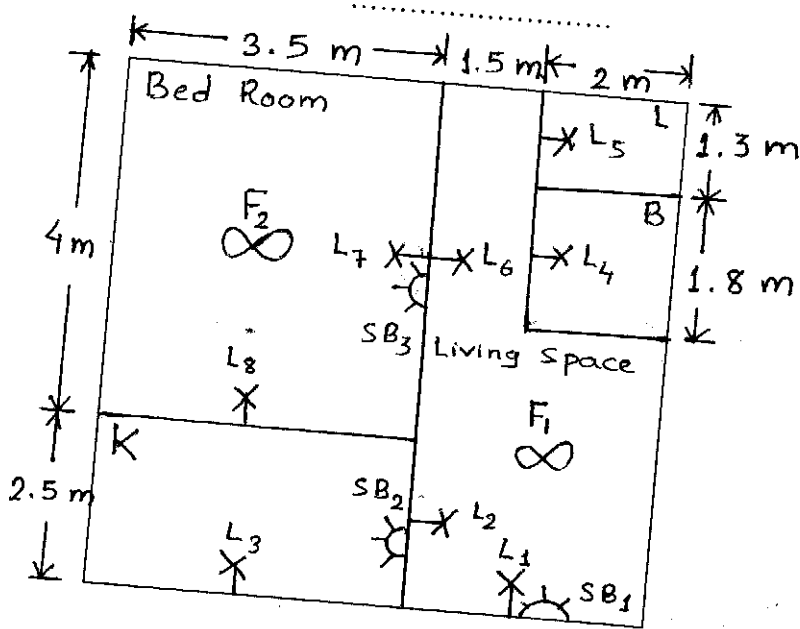

The above figure shows **line plan** of the building and name is assigned to each apparatus.

**Calculation of load:**

There are :

8 Nos. of light points	=	8 x 100W	=	800 W
2 Nos. of fan points	=	2 x 60 W	=	120 W
3 Nos. of plug points	=	3 x 100 W	=	<u>300 W</u>

Total 13 load point = 1220 W

Since, the load is greater than 800 W and there is more than 10 points, then there will be 2 circuits for electrical installation.

$$\text{Let, } V = 230 \text{ V and p.f.} = 0.85$$

$$D = \frac{W}{V \cos} = \frac{1220}{230 \times 0.85} = 6.24 \text{ A}$$

$$\begin{aligned} \text{Safe current 'D}_s\text{'} &= \text{F.S.} \times I \\ &= 1.5 \times 6.24 = 9.36 \text{ A} \end{aligned}$$

Single line wiring diagram

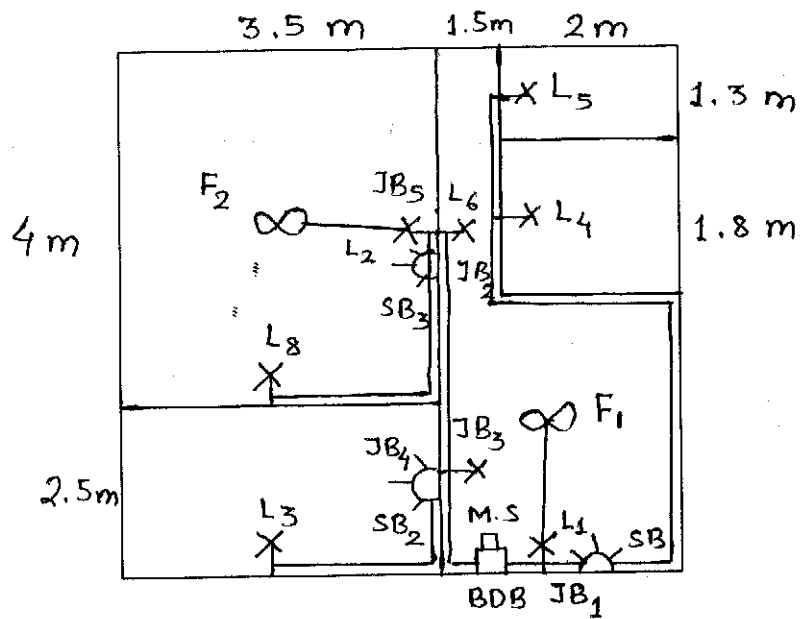

**Calculation of batten length and wires.**

Location	No. of wires	Length of batten					Bend	Corner	Conduit	Remarks
		13 x 13	19 x 13	25 x 13	31 x 13	37 x 13				
MS to BDB	2	1.5	-	-	-	-	-	-	-	
<b>Circuit - 1</b>										
BDB to JB <sub>1</sub>	2	1	-	-	-	-	-	-	-	
JB <sub>1</sub> to SB <sub>1</sub> (Via L <sub>1</sub> )	6	-	-	-	-	1.5	-	-	-	
JB <sub>1</sub> to F <sub>1</sub>	2	2.5	-	-	-	-	-	1	-	
JB <sub>1</sub> to JB <sub>2</sub>	3	-	8.3	-	-	-	-	3	-	
JB <sub>2</sub> to L <sub>4</sub>	2	0.5	-	-	-	-	-	1	0.3	
JB <sub>2</sub> to L <sub>5</sub>	2	1.7	-	-	-	-	-	2	0.3	
<b>Circuit - 2</b>										
BDB to JB <sub>3</sub>	2	2	-	-	-	-	-	1	-	
JB <sub>3</sub> to JB <sub>4</sub>	2	-	-	-	-	-	-	-	0.3	
JB <sub>4</sub> to SB <sub>2</sub>	4	-	-	1.5	-	-	-	-	-	
JB <sub>4</sub> to L <sub>3</sub>	2	3.7	-	-	-	-	1	1	-	
JB <sub>3</sub> to L <sub>2</sub>	2	0.5	-	-	-	-	-	-	-	
JB <sub>3</sub> to JB <sub>5</sub>	2	3	-	-	-	-	-	1	0.3	
JB <sub>5</sub> to SB <sub>3</sub> (Via L <sub>7</sub> )	6	-	-	-	-	1.5	-	-	-	
JB <sub>5</sub> to F <sub>2</sub>	2	2.2	-	-	-	-	-	1	-	
JB <sub>5</sub> to L <sub>8</sub>	2	4.2	-	-	-	-	1	1	-	
JB <sub>5</sub> to L <sub>6</sub>	2	0.5	-	-	-	-	-	1	0.3	
Total:		23.3	8.3	10.15	-	3.3	-	13	1.5	
Add. 10% extra for waste etc.		2.3	0.8	-	-	0.3	2.0	-	-	
Grand total		25.6	9.1	1.65	-	3.3	-	13	2.0	
Round off		26.0	9.0	2.00	-	4.0	2.0	13	2.0	

Length of S.C where =  $2 \times 26 + 3 \times 9 + 4 \times 2 + 6 \times 4 + 2 \times 2$   
 =  $52 + 27 + 8 + 24 + 4$   
 = 115 m

Length of E.C.C. =  $26 + 9 + 2 + 4 + 2$   
 = 43 m

**Schedule of materials:**

Sl. No.	Description	Quantity	Unit	Remarks
1	ICDP Main Switch 16A, 250V	1	No.	M.S
2	ICDPBDB 3 Way, 16A/way	1	No.	
3	One way switch GA, 250V	13	Nos.	
4	Batten holder Bakelite pin type	8	Nos.	All light points
5	Two plate ceiling rose	2	Nos.	
6	3 Ph socket outlet 6A, 250V	3	Nos.	
7	TW Batten			
	a) 13 x 13	26	m	
	b) 19 x 13	09	m	
	c) 25 x 13	02	m	
	d) 37 x 13	4	m	
8	19 mm conduit	2	m	
9	TW bends / corner	1.5	Doz.	
10	TW Boards			
	a) 10 cm x 10 cm	05	Nos.	All junction box
	b) 30 mm x 20 cm	02	Nos.	MS & BDB
	c) 30 mm x 25 cm	03	Nos.	Switch boards
11	TW round block, 10 cm x 2.5 cm double	10	Nos.	All light & fan point
12	TW plug 2.5 sq.cm x 1.9 sq.cm x 5 cm long.	12	Dozen	
13	NF Screw			
	a) 19 mm x 6 SWG	12	Dozen	
	b) 19 mm x 4 SWG	06	Dozen	
	c) 13 mm x 6 SWG	06	Dozen	
14	Link clips			
	a) 44	02	Pkt.	2:1
	b) 54	03	Pkt.	2:1
15	Brass nail 10 mm	125	gm	
16	SC PVC Al. wire 1.5 mm <sup>2</sup>	115	m	
	SC PVC Al. wire 2.5 mm <sup>2</sup>	03	m	
17	14 SWG Tinned Cu	43		
18	Sand, Cement etc.	L.S		



Table-8

'G'-Series Miniature Circuit Breakers as Back up Protection with Motor D.O.L. or Star Delta Motor Starters.

Motor HP at 415 V 3 Phase	Full Load Current Amps	Recommended Rating of TP MCB
2	3.5	4Amps
3	4.8	5Amps
5	7.5	7.5Amps
7.5	11	16Amps
10	14	16Amps
12.5	17	20Amps
15	20	20Amps
17.5	24	25Amps
20	30	32Amps

### DATA FOR WIRES AND CABLES

Table-9.

Comparison of Aluminum and Copper Conductors

Particulars	Aluminum	Copper
(A) For equal resistance		
(i) Area Ratio	1.61	1
(ii) Diameter ratio for round conductors	1.27	1
(iii) Weight ratio	0.48	1
(B) For Equal current and temperature rise		
(i) Area ratio	1.39	1
(ii) Diameter ratio for round conductor	1.18	1
(iii) Weight ratio	0.42	1
(C) For equal diameter		
(i) Resistance ratio	1.61	1
(ii) Current carrying capacity	0.78	1

**Table-10**

**Current Rating of Copper Conductor Single core cables (V.I.R.,PVC or lythene insulated including tough rubber sheathed, P.V.C OR Lead sheathed)**

Size of conductor		Two cable d.c. or single phase a.c		Three or four cables balanced three phase a.c	
Nominal area (mm <sup>2</sup> )	No. and dia of Wire in (mm)	Current Rating (amps)	Approximate Length of run for one volt drop(mt)	Current Rating (amps)	Approximate Length of run For one volt drop(mt)
1.0	1/1.12	5	4.9	5	5.8
1.5	3/.737	10	3	10	3.7
2.5	3/1.06	15	3.4	13	4.3
4.0	7/.737	20	3.7	15	5.2
6.0	7/1.06	28	4.0	25	5.8
8.0	7/1.12	36	4.9	32	6.1
10.0	7/1.40	43	5.5	39	7.0
15.0	7/1.63	52	7.0	48	8.8
20.0	19/1.12	62	7.6	56	9.8
25.0	19/1.40	74	8.8	67	11.3
35.0	19/1.63	97	10	88	12.8
50.0	19/1.80	160	19.4	155	13.4

**Table-11**

**Current Rating of Aluminum conductor Single core cables (V.I.R., PVC or polythene insulated tough rubber, P.V.C OR Lead sheathed)**

Size of conductor		Two cable d.c or Single phase a.c		Three or four cables balanced three phase		Four cables d.c or Single phase a.c	
Nominal area (mm <sup>2</sup> )	No. and dia of Wire in (mm)	Current Rating in (amps)	Approx. Run for one volt drop (mt)	Current Rating (amps)	Approx. Run for one volt drop (mt)	Current Rating (amps)	Approx. Run for one volt drop (mt)
1.5	1/1.40	10	2.3	9	2.9	9	2.5
2.5	1/1.80	15	2.5	12	3.6	11	3.4
4	1/2.24	20	2.9	17	3.9	15	4.1
6	1/2.80	27	3.4	24	4.3	21	4.3
10	1/3.55	34	4.3	31	5.4	27	5.4
16	7/1.70	43	5.4	38	7.0	35	6.8
25	7/2.24	59	6.8	54	8.5	48	8.5
35	7/2.50	69	7.2	62	9.3	55	9.0
50	7/3.00 19/1.80	91	7.9	82	10.1	69	10.0
70	19/2.24	134	9.0	131	9.5	-	-
95	19/2.50	153	9.8	152	10.0	-	-
120	37/2.06	165	10.8	161	10.9	-	-
150	37/2.24	181	11.4	179	11.1	-	-
185	37/2.50	209	12.3	207	11.8	-	-
225	37/2.80	240	13.5	235	13.1	-	-

Table -12.

Current rating of copper conductor Twin, Three and Four Core Cables. Three core and Four Core cables (VIR, PVC or Polythene insulated and sheathed with tough rubber P.V.C or lead sheathed).

Size of conductor		Two cable d.c or Single phase a.c		One three core or four core Cable balanced three phase	
Nominal area (mm <sup>2</sup> )	No. and dia of Wire in (mm)	Current Rating in (amps)	Approx. Run for one volt drop (mt)	Current Rating in (amps)	Approx. Run for one volt drop (mt)
1.0	1/1.12	5	4.6	5	5.5
1.5	4/737	10	3.0	8	5.3
2.5	3/1.06	15	3.0	10	5.5
4.0	7/737	20	3.4	15	5.5
6.0	7/1.06	28	4.0	20	6.4
8.0	7/1.12	36	4.6	25	7.6
10.0	7/1.40	43	5.2	30	8.8
15.0	7/1.63	53	6.4	37	11.0
20.0	19/1.12	62	7.0	43	11.9
25.0	19/1.40	74	8.2	52	13.7
35.0	19/1.63	97	9.8	68	15.8
50.0	19/1.80	140	11.3	88	18.3

Table-13

.Current rating and voltage drop for vulcanised rubber , P.V.C, or Polythene insulated or tough rubber PVC Lead sheathed , twin three or four core aluminium wire or cables.

Size of conductor		One twin core D.C. or Single phase A.C.			One 3 core or 4 core cable balanced three phase	
Nominal area (mm <sup>2</sup> )	No. and dia of Wire in (mm)	Current Rating in (amps)	Approximate length of run for 1-volt drop		Current Rating in (amps)	App. length of run for one volt drop in meters
			D.C. metres	A.C. metres		
1.5	1/1.40	10	2.3	2.3	7	3.7
2.5	1/1.80	15	2.5	2.5	11	3.9
4.0	1/2.24	20	2.9	2.9	14	4.8
6.0	1/2.80	27	3.4	3.4	19	5.5
10.0	1/3.55	34	4.2	4.2	24	6.8
16.0	7/1.70	43	5.3	5.3	30	8.7
25.0	7/2.24	59	6.6	6.6	42	10.8
35.0	7/2.50	69	7.1	7.1	48	11.7
50.00	7/3.0 19/1.80	91	7.7	7.7	62	13.1

Table -14..

Current rating in amperes as per I.S.S.692-1965 for three core screened Aluminum conductors Lead Alloy Sheathed, double steel tape/single wire Armoured 33kv Under ground cables .

Nominal area of conductor in sq. mm	Maximum continuous Current Rating		
	In Ground amps.	In Duct amps.	In Air amps.
70	150	130	125
95	170	150	140
120	200	180	165
150	240	220	200
185	265	245	215
240	320	275	255
300	360	320	290

Table-15

.Current rating in amperes as per I.S.1554-1961 for Aluminium conductor P.V.C.1100 volts under ground cables.

Nominal area in sq. mm	Number and diameter of wires in mm.	Current rating for single core	Current Rating for cables in ground		Current Rating for Cable in air	
			2-core	3 and multicore	2-core	3 and multicore
6	1/2.80	37	53	47	43	38
10	1/3.55	51	70	63	59	50
16	7/1.70	68	91	86	76	69
25	7/2.24	90	120	106	99	82
35	7/2.50	112	142	129	123	106
50	19/1.80	139	175	156	152	129
70	19/2.24	172	215	191	189	156
95	19/2.50	207	248	231	227	188
120	37/2.06	242	282	266	262	215
150	37/2.24	278	323	305	301	246
185	37/2.50	316	380	350	320	285
240	37/3.00	381	445	410	365	330
300	61/2.50	440	500	470	410	375
400	61/3.00	500	600	560	490	450
500	91/2.65	540	-	-	-	-

Table -16.

Current rating in amperes as per I.S.S.692-1965 for three core screened Aluminium conductors Lead alloy sheathed double steel tape/single wire armoured 22kv under ground cables.

Nominal area of conductor in sq. mm	Maximum continuous Current Rating		
	In Ground amps.	In Duct amps.	In Air amps.
25	90	80	70
35	110	100	90
50	135	120	110
70	170	155	135
95	195	175	155
120	230	210	185
150	260	235	210
185	290	260	230
240	340	305	270
300	385	345	310

Table- 17

Sizes of Flexible PVC wires

Nominal cross-sectional Area of twin Flexible cord mm <sup>2</sup>	Number and diameter in mm of wires	Maximum Permissible Weight in Kg per coil
0.5	16/0.2	2
0.75	24/0.2	3
1.0	32/0.2	5
1.5	48/0.2	5.3
2.5	80/0.2	8.8
4.0	128/0.2	14.0

Table-18

Current Rating as per I.S.S.692-1965 in amperes for aluminium conductor paper insulated mass impregnated lead covered 1100v under ground cable.

Nominal area in sq. mm	Number and size of wires  in mm	Current Rating for cables laid in ground			Current Rating for Cable laid in ducts			Current Rating for Cable laid in air		
		Single core unarmoured	Twin core	Three and multi-core	Single core unarmoured	Twin core	Three and multi-core	Single core unarmoured	Twin core	Three and multi-core
6	1/2.80	50	57	48	42	44	40	56	48	40
10	1/3.55	70	74	62	56	60	51	72	66	56
16	7/1.70	90	96	81	76	80	68	94	88	72
25	7/2.24	115	122	107	98	108	90	124	117	97
35	7/2.50	138	147	128	116	130	105	151	141	119
50	19/1.80	172	180	158	140	159	128	184	177	150
70	19/2.24	208	219	192	170	190	156	227	220	182
95	19/2.50	244	262	224	198	224	184	272	258	224
120	37/2.06	278	302	257	222	254	211	312	298	258
150	37/2.24	316	346	296	249	287	243	358	339	300
185	37/2.50	359	398	336	279	323	278	412	387	348
240	37/3.00	430	485	413	335	397	340	520	492	437
300	61/2.50	466	536	438	358	422	364	570	524	475
400	61/3.00	553	618	513	412	515	425	680	635	545
500	81/2.80	595	-	-	445	-	-	760	-	-
625	91/3.00	670	-	-	490	-	-	895	-	-

Table-19

**Current Rating of Aluminium conductor Twin, Three core or Four core cables (VIR,PVC or Polythene insulated and sheathed with tough rubber ,PVC or lead sheathed).**

Size of conductors		One twin core cable d.c. or Single phase a.c.		One three-core or four core Cable balanced three phase	
Nominal area (mm <sup>2</sup> )	No. and dia. of wire(mm)	Current Rating (amps)	Approx. length of run for one volt drop(mt)	Current rating (amps)	Approx. length of run for one (mt)
1.5	1/1.40	10	2.3	7	3.7
2.5	1/1.80	15	2.5	11	3.9
4.0	1/2.24	20	2.9	14	4.8
6.0	1/2.80	27	3.4	19	5.5
10.0	1/3.55	34	4.2	24	6.8
16.0	7/1.70	43	5.3	30	8.7
25.0	7/2.24	59	6.6	42	10.8
35.0	7/2.50	69	7.1	48	11.7

Table-20

**Current Rating of Copper conductor Single core cables (VIR,PVC or Polythene insulated including tough rubber sheathed ,PVC or lead sheathed)**

Size of conductors		Two cables d.c. or Single Phase a.c		Three or four cables balanced three phase a.c.	
Nominal area mm <sup>2</sup>	No. and dia. of wire(mm)	Current Rating (amps)	Approximate Length of run for one volt drop(mt)	Current Rating(amps)	Approximate Length of run for one volt drop(mt)
1.0	1/1.12	5	2.9	3	2.8
1.5	3/1.37	10	3	10	3.7
2.5	3/1.06	15	3.4	13	4.3
4.0	7/1.37	20	3.7	15	4.8
6.0	7/1.06	28	4.0	25	5.2
8.0	7/1.12	36	4.9	32	6.1
10.0	7/1.40	43	5.5	39	7.0
15.0	7/1.63	52	7.0	48	8.8
20.0	19/1.12	62	7.6	56	9.8
25.0	19/1.40	74	8.8	67	11.3
35.0	19/1.63	97	10	88	12.8
50.0	19/1.80	160	19.4	155	13.4



Table-21

Current Rating of Aluminium conductor Single core cables (VIR,PVC or Polythene insulated including tough rubber sheathed ,PVC or lead sheathed)

Size of conductors		Two cables d.c . or Single Phase a.c		Three or four cables balanced three phase a.c.		Four cables d.c. or Single phase a.c	
Nominal area mm <sup>2</sup>	No. and dia. of wire(mm)	Current Rating (amps)	Approx run for one volt drop(Mt)	Current Rating (amps)	Approx run for one volt drop(mt)	Current Rating (amps)	Approx run for one volt drop(mt)
1.5	1/1.40	10	2.3	9	2.9	9	2.5
2.5	1/1.80	15	2.5	12	3.6	11	3.4
4	1/2.24	20	2.9	17	3.9	15	4.1
6	1/2.80	27	3.4	24	4.3	21	4.3
10	1/3.55	34	4.3	31	5.4	27	5.4
16	7/1.70	43	5.4	38	7.0	35	6.8
25	7/2.24	59	6.8	54	8.5	48	8.5
35	7/2.50	69	7.2	62	9.8	55	9.0
50	7/3.00	91	7.9	82	10.1	69	10.0

Table-22

Current Rating in amperes as per I.S.692-1965 for Aluminium conductor paper insulated mass impregnated lead covered 3.3 kv under ground cables

Nominal area in sq. mm	Number and size of wires in mm	Current Rating for cables laid in ground		Current Rating for Cable laid in ducts		Current Rating for Cable laid in air	
		Single core unarmoured	3 or more core armoured	Single core unarmoured	3 or more core armoured	Single core unarmoured	3 or more core armoured
25	7/2.24	110	100	96	90	120	101
35	7/2.50	130	120	116	110	150	123
50	19/1.80	160	150	142	134	185	152
70	19/2.24	198	184	170	162	228	190
95	19/2.50	233	218	199	190	279	226
120	37/2.06	263	250	224	216	318	259
150	37/2.24	297	283	252	244	354	299
185	37/2.50	335	320	282	278	419	347
240	37/3.00	400	380	340	335	525	436
300	61/2.50	433	394	359	355	575	474
400	61/3.00	520	490	420	390	725	695
500	61/2.80	558	-	460	-	785	-
625	91/3.00	620	-	500	-	910	-

## LIGHTING SCHEME

**Table-23**  
**Recommended Illumination level required for various locations in Residential and commercial buildings**

Type of Work	Recommended Illumination Level in lux	Type of Work	Recommended Illumination Level in lux
Offices :Drawing Office	400	Industry:Rough Work Forging	120
Normal office	250	etc.	150
work,bookkeeping,typing	50 to75	Ordinary bench work	400
Stairs ,corridor, waiting room	500	Fine bench and machine work	1000
Shops: Sales premises, show room etc.	250	Very fine work such as making	
Other premises of shops	75	Watches	150-200
Hotels: Bed rooms	300	Domestic: Bed room	250
Study table in bed room	80	Living room	200
Kitchen, lounge & dining room	80 to 100	Kitchen	50-75
Stairs, corridor, reception	250	Bath room	200
Schools/College :Class room	400	Bath room mirror	500
Painting,art and drawing room	150	Sewing and embroidery	100
Laboratories	1000	Stairs, Lobby, reception room	300
Tennis ground(Lawn or table)	250	Study room	50
Hospitals: Laboratory	3000	Garage	300
Operation table	100	Table games	200
Patient ward		Drawing room	125
		Dining room	

**Table-24**  
**Illumination level of different kinds of lamps**

Description of the lamp	Lumen efficiency/watt.	Lumen output at 230 volt
<b>1. Fluorescent lamp 80 watts-5ft. warm white</b> <b>40 watts-4 ft. warm white</b> <b>20 watts-2 ft. warm white</b>	<b>58</b> <b>60</b> <b>46</b>	<b>4640</b> <b>2400</b> <b>920</b>
<b>2. Incandescent lamp 40 watts</b> <b>60 watts</b> <b>100 watts</b> <b>150 watts</b> <b>200 watts</b> <b>300 watts</b> <b>500 watts</b> <b>1000 watts</b>	<b>10</b> <b>12</b> <b>13.80</b> <b>14</b> <b>14.75</b> <b>16</b> <b>16.9</b> <b>19</b>	<b>400</b> <b>720</b> <b>1380</b> <b>2100</b> <b>2950</b> <b>4800</b> <b>8450</b> <b>1900</b>
<b>3. Mercury discharge lamps 80 watts</b> <b>125 watts</b> <b>250 watts</b> <b>400 watts</b>	<b>31</b> <b>31</b> <b>35</b> <b>39</b>	<b>2480</b> <b>3875</b> <b>8750</b> <b>15600</b>
<b>4. Sodium discharge lamps 45 watts</b> <b>60 watts</b> <b>85 watts</b> <b>140 watts</b>	<b>50</b> <b>57</b> <b>65</b> <b>70</b>	<b>2250</b> <b>3420</b> <b>5525</b> <b>9100</b>

Table -25  
Average Illuminations Required at Various Places

Types of Room	Lumens per sq. Mt.(Lux)
Living Rooms	75
Work Benches	160
Office work	215
Typewriting	215
Drawing office	320
Reading Table	160
Verandah	55

Table-26

Average Lumen Output of 230v Lamp

Lumen Output			
Watts	Single coil	Coiled coil	Fluorescent tube
20	-	-	810
25	113	-	-
40	206	-	2160
60	330	390	-
75	284	665	-
80	-	-	3880
100	785	883	-
200	1970	2190	-
500	7930	-	-
1000	17800	-	-

Table-27

## GENERAL PROVISION OF LOAD POINTS

	Lamp points	Fluorescent Tube	Socket 5 Amp	Socket 5/15 Amp	Ceilingfan Med.size	Ceiling fan Large size	Exhaust Fan
Bed Room 3m x 3m	1	1	1	-	1	-	-
Bed Room 4m x 4m	1	1	2	-	-	1	-
Bed Room 5m x 4m	1	1	1	1	-	1	-
Bed Room 6m x 4m	1	1	2	1	2	-	-
Drawing Room Med.Size	1	2	2	1	1	1	-
Drawing Room Large Size	2	2	2	1	-	2	-
Drawing cum Dining Room	1	2	2	-	1	1	-
Kitchen	2*	-	-	1	-	-	1
Garage	1	-	1	-	1	-	-
Bath Room	1	-	-	1	-	-	1
Verandah 4m x 2m	1	-	1	-	-	-	-
Verandah 4m x 3m	-	1	1	-	1	-	-
Verandah 6m x 3m	1	1	1	-	2	-	-
Store	1	-	-	-	-	-	-
Pooja Room Small Size	-	1	1	1	1	-	-
Lobby 5m x 3m	1	1	2	1	2	-	-
For Air conditioner of Medium Capacity	A two pole switch of appropriate rating						

# EARTHING

## Earthing:

The meaning of the term earthing is to connect the electrical equipment to the general mass of earth by ---- of negligible resistance. This brings the body of the electrical equipment to zero potential and there will avoid the shock to the operator. The main purpose of earthing is the safety from electric shock. In case of earth fault, heavy current flow through the circuit, the circuit fuse melts out or trips the MLD of the circuit, and faulty circuit will be disconnected from the supply.

Types of earthing:

There are two types of earthing.

- a) Plate earthing.
- b) Pipe earthing.

a) Plate earthing:

List out the material used in plate earthing with sketch.

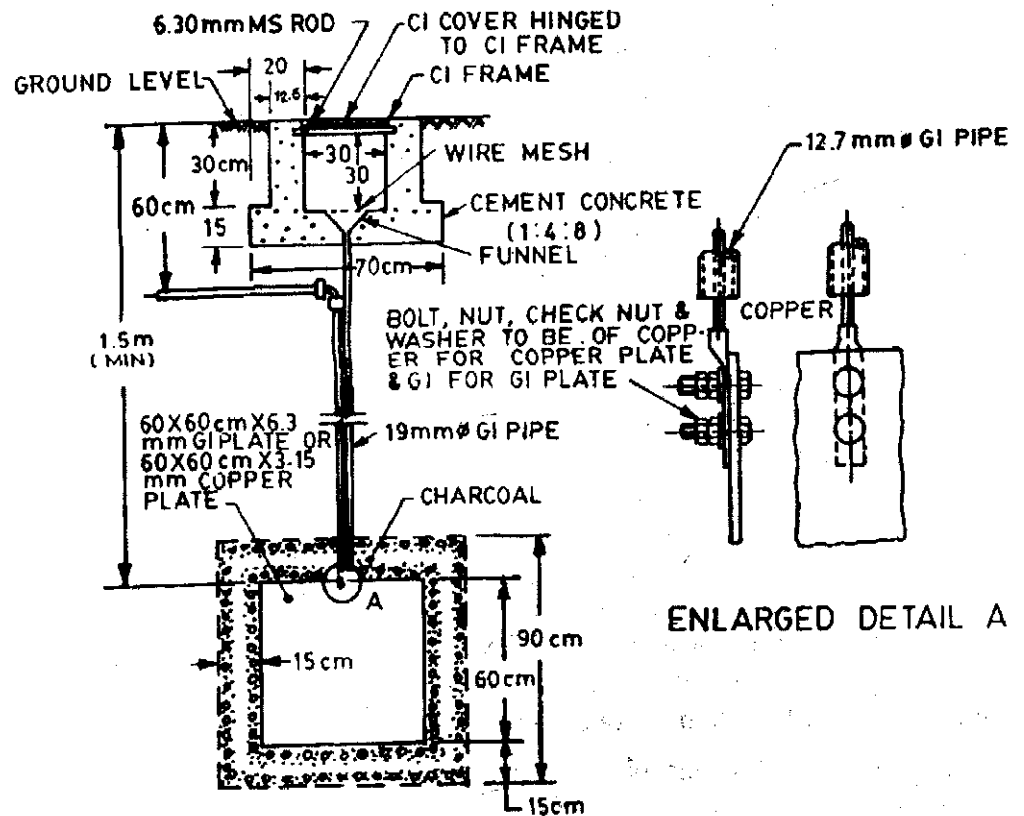

Figure 4.15: A typical illustration of plate earthing.

## Pipe earthing.

List out the material used in plate earthing with sketch

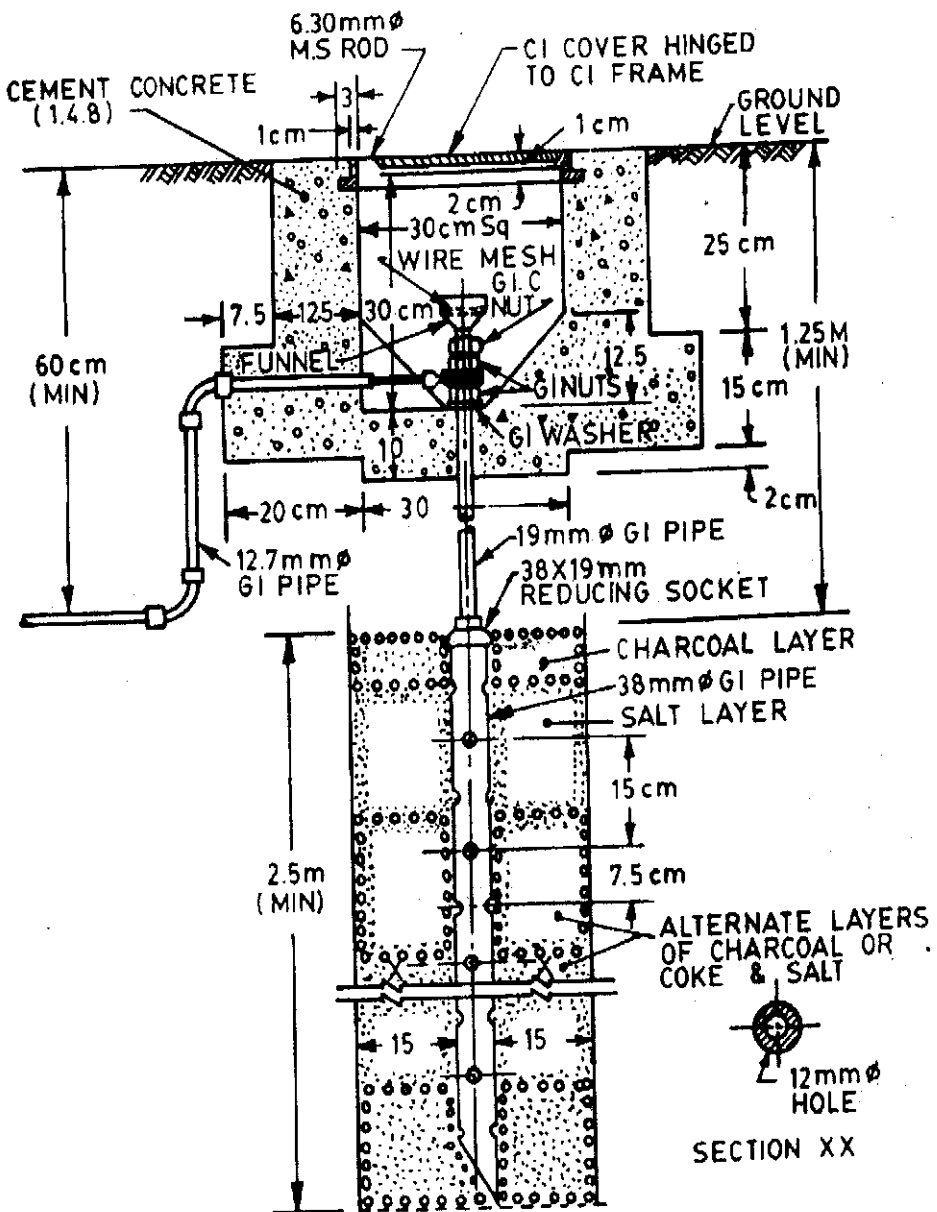

Figure 4.14: A typical illustration of pipe earthing.

Table-28  
EARTHING LEAD

Type of loads and installation	Size of earth lead				Size of earth electrode	
	Copper		GI		Copper	GI
	SWG	Area in Sq. mm	SWG	Area in Sq mm		
Consumers residential premises	8	12.97	8	12.97	60cm x60 cmx3.18mm	60 cm x60cmx6.35mm
Pole earthing of transmission or distribution lines	do	do	do	do	do	do
Industrial loads upto 10 H.P	do	do	do	do	do	do
Industrial loads between 10 H.P. to15 H.P	do	do	6	18.68	do	do
Industrial loads between 15H.P. to30 H.P	6	18.68	2	38.60	do	do
Industrial loads between 30 H.P. to50 H.P	4	27.27	Not	Used	90cm x 90cmx6.35mm	90cm x90 cm x 6.35mm
Industrial loads between 50 H.P. to100 H.P	(i) 2	38.60	Not	Used	90cm x 90cm X6.35mm	not used
Industrial load above 100HP	(ii)copper Strip	12.7mmx 2.54mm	not	used	90cmx90cmx 6.35mm	not used
	Copper strip	25.4mm x 2.54mm	not	used	90 cm x 90 cm x 6.35mm	not used
Power houses and sub-Stations(chain of several earthing sets installed). Detail as under : Capacity of Transformer/ Generating set	Copper strip	20mm x 4 mm	not	-	do	not used
(a)Upto 300 KVA	Copper strip	32 mm x 5mm or 40 mm x 4 mm	-	-	do	-
(b)Above 300 KVA but not exceeding 500 KVA	do	40mm x 6.3mm or 50mm x 5mm	-	-	do	-
©Above 500 KVA but not exceeding 800 KVA	do	50 mm x6.3mm or two 32mm x 5mm or two 40 mm x 4 mm	-	-	do	-
(d)Above 800 KVA but not exceeding 1000 KVA	do	do	-	-	do	-



**Table -29**

Condition of body	Electric resistance of body ohms	100 v		500v		10,000v	
		Current A	Effect	Current A	Effect	Current A	Effect
Totally wet	1000	0.1	Certain death and slight burns	0.5 A	Burns, Probable death	10	Severe burns, may survive
Neither wet nor dry	5,000	0.02	No burns or injury, painful shock	0.1	Certain death, slight burns	2	Severe Burns, may survive
Dry	1,00,000	0.001	Very light Shock no burns	0.005	Light shock no burns	0.1	Sure death Slight burns

**Table-30**

**Minimum bending radius of insulator cables**

Voltage	Minimum bending radius		
	Single core cable	Multicore cable	
		Unarmoured	Armoured
Upto 11 KV	20D	15D	12D
Upto 22 KV	25D	20D	15D
Upto 33 KV	30D	25D	20D

D=Overall diameter of cable

**Table- 31**

**Current rating of hard drawn bare copper conductor**

Conductor strands	Weight in Kg/Km	Ultimate tensile strength	Current Rating for temperature rise of	
			27.8° C	55.5° C
3/1.62	131.4	622.3	52	70
3/2.64	149.1	688.7	68	88
3/3.73	298.1	1317	110	149
7/2.64	346.9	1606	124	168
7/3.45	593.3	2662	186	251
7/4.22	884.3	3863	250	338
4/4.90	1195.0	5112	314	423
19/2.94	1174.0	5194	314	423
7/5.46	1484.0	6261	370	500
19/3.33	1497.0	6609	370	500

**Table-32**  
**Aluminium Bus Bar Section**

Current Rating in Amps upto	Recommended rectangular cross section in mm	Recommended Sections Nominal dia. In mm	Circular Nominal thickness in mm
100	25 x 6	-	-
200	38 x 6	-	-
300	51 x 6	25.0	3.38
400	63 x 6	32.0	3.56
500	76 x 6	32.0	3.56
600	102 x 6	38.0	3.68
700	102 x 6	51.0	3.91
800	127 x 6	51.0	3.91
900	127 x 6	63.0	5.16

**Table -33.**

Current Rating in amperes as per I.S.S.692-1965 for Aluminium conductor paper insulated mass impregnated lead covered 11 kv under ground cables.

Nominal area in sq. mm	Number and size of wires in mm	Current Rating for cables in ground		Current Rating for Cable laid in ducts		Current Rating for Cable in air	
		Single core unarmoured	3 core Armoured	Single core unarmoured	3 core armoured	Single core unarmoured	3 core armoured
25	7/2.24	100	90	95	78	110	86
35	7/2.50	119	109	104	94	136	104
50	19/1.80	147	134	126	116	170	132
70	19/2.24	182	165	151	142	213	162
95	19/2.50	214	194	176	170	255	192
120	37/2.06	244	218	198	192	288	224
150	37/2.24	275	249	222	219	326	258
185	37/2.50	308	284	248	245	372	294
240	37/3.00	365	341	290	285	470	368
300	61/2.50	394	360	310	305	507	400
400	61/3.00	475	440	370	340	640	610
500	91/2.80	575	-	400	-	705	-
625	91/3.00	580	-	435	-	820	-

**Table-34**  
Resistance of Insulated underground cables

Nominal area in sq. mm	Number and nominal diameter of Wires in mm	Maximum allowable Resistance per km. at 20° c for single core cables in ohms	Maximum allowable resistance per km at 20° c for twin and multicore cables in ohms
6	1/2.80	4.759	4.851
10	1/3.55	2.960	3.018
16	7/1.70	1.876	1.912
25	7/2.24	1.080	1.102
35	7/2.50	0.8675	0.8843
50	19/1.80	0.6176	0.6299
70	19/2.24	0.3988	0.4068
95	19/2.50	0.3201	0.3263
120	37/2.06	0.2423	0.2470
150	37/2.24	0.2049	0.2088
185	37/2.50	0.1645	0.1677
225	37/2.80	0.1311	0.1337
240	37/3.00	0.1142	0.1165
300	61/2.50	0.09979	0.107
400	61/3.00	0.06930	0.07069
500	91/2.65	0.05960	-
625	91/3.00	0.04645	-

**Table-35**  
Current rating for hard drawn solid copper conductor for overhead lines

SWG Number of conductor	Weight in Kg/km	Diameter of conductor in mm	Nominal cross-sectional area in mm <sup>2</sup>	Current Rating for Temperature rise of	
				27.8° C in amperes	55.5° C in amperes
10	73.79	3.251	8.30	37	50
9	93.43	3.658	10.51	44	60
8	115.32	4.064	12.97	52	70
7	139.53	4.470	15.70	58	81
6	166.06	4.877	18.68	68	92
5	204.4	5.385	22.77	78	107
4	242.4	5.893	26.27	91	122
3	286.1	6.401	32.18	103	139
2	343.2	7.010	38.60	117	158
1	405.4	7.620	45.60	133	181
0	472.9	8.230	53.19	150	203
00	545.4	8.839	61.36	167	226
000	623.4	9.449	70.72	184	250
0000	840.7	10.160	81.07	205	278

Table-36  
Current Rating of 3 Phase Motors and Recommended size of Cables

BHP of motor	3 phase 400 volts	Rated current amp.	Starting or overload current amps.	Insulation	Met al	Single core cable recommened
1	400 volts	2	3	PVC	Al	4.0sq mm 1/2.28 mm dia minimum size
3	400 volts	5	7.5	PVC	Al	-do-
5	400volts	8	12	PVC	Al	6mm <sup>2</sup> or 1/2.80mm
7.5	400 volts	12	18	PVC	Al	6mm <sup>2</sup> or 1/2.80mm
10	400 volts	15	22	PVC	Al	6mm <sup>2</sup> or 1/2.80 mm(starting current limited by star delta starter)
15	400 volts	22	30	PVC	Al	10 sq. mm or 1/3.55 mm(starting current limited by star /delta starter)
20	400 volts	29	35	PVC	Al	16 sq. mm or 7/1.70 mm(starting current limited by star /delta starter)
30	400 volts	42	50	PVC	Al	25mm <sup>2</sup> or 7/2.24 mm(at 20% overload) starting current limited by auto-transformer starter
40	400 volts	56.5	68	PVC	Al	35mm <sup>2</sup> or 7/2.50 mm (at 20% overload) No starting current.
50	400 volts	71	85	PVC	Al	50 mm <sup>2</sup> or 7/3.0 mm(at 20% overload)No starting current.

Table -37

Current Rating for AC single phase and Three phase motors(approx).

BHP of Motor	Current Rating Per phase of Induction Motors allowing allowance for efficiency and p. f.		
	Single phase 230 volts	Three phase 400 volts	Three phase 440volts
0.125	1.0	0.3	0.3
0.25	1.8	0.7	0.6
0.50	3.5	1.2	1.0
0.75	4.8	1.7	1.4
1.0	6.2	2.0	1.7
1.25	7.4	2.5	2.2
1.50	8.7	2.8	2.5
1.75	10.0	3.2	2.8
2.0	11.8	3.5	3.2
2.50	14.0	4.3	4.0
3.0	17.5	5.0	4.5
4.0	20.0	6.5	6.0
5.0	24.0	8.0	7.5
7.5	36.0	12.0	11.0
10.0	47.0	15.0	14.0
12.5	59.0	19.0	18
15.0	70.0	22.0	21.0
20.0	91.0	29.0	28.0
30.0	135.0	42.0	39.0
40.0	183.0	56.0	53.0
50.0	227.0	71.0	66.0

Table- 38  
 .Current Rating for A.C.S.R. Conductor for Overhead Lines.(I.S. 398-1961)

Code word	No of Aluminium wires	No of steel wires	Diameter of wire in mm	Number and diameter of wire in mm	Diameter of conductor in mm	Approximate weight of conductor in Kg/km	Approximate ultimate tensile strength of conductor in kg	Approximate current carrying capacity in amperes	
								At ambient temperature of 40 <sup>0</sup> C	At ambient temp of 45 <sup>0</sup> C
Squirrel	6	1	2.11	6/1x2.11	6.33	85	771	115	107
Gopher	6	1	2.36	6/1x2.36	7.08	106	952	133	123
Weasel	6	1	2.59	6/1x3.59	7.77	128	1136	150	139
Ferret	6	1	3.00	6/1x3.00	9.00	171	1503	181	168
Rabbit	6	1	3.55	6/1x3.35	10.05	214	1860	208	193
Mink	6	1	3.66	6/1x3.66	10.98	255	2207	234	217
Mink	6	1	3.99	6/1x3.99	11.97	303	2613	261	242
Raccoon	6	1	4.09	6/1x4.09	12.27	318	2746	270	250
Otter	6	1	4.22	6/1x4.22	12.66	339	2923	281	260
Cat	6	1	4.50	6/1x4.50	13.50	385	3324	305	283
Dog	6	7	4.72	6/1x4.72	14.15	394	3299	324	300
Leopard	6	7	5.28	6/1x5.28	15.84	493	4137	375	348
Tiger	30	7	2.36	30/7x2.36	16.52	604	5758	382	354
Wolf	30	7	2.59	30/7x2.59	18.13	727	6880	430	398
Lynx	30	7	2.79	30/7x2.79	19.53	844	7950	475	440
Panther	30	7	3.00	30/7x3.00	21.00	976	9127	520	482
Lion	30	7	3.18	30/7x3.18	22.26	1097	10210	555	515
Bear	30	7	3.55	30/7x3.55	23.45	1229	11310	595	552
Goat	30	7	3.71	30/7x3.71	25.97	1492	13760	680	630
Sheep	30	7	3.99	30/7x2.99	27.93	1726	15910	745	690
Dear	30	7	4.27	30/7x4.27	29.50	1977	18230	806	747
Eik	30	7	4.50	30/7x4.50	31.50	2196	20240	860	796
Mouse	54	7	3.53	54/7x3.53	31.77	2002	16250	900	835

Table-39

## Current Rating for All Aluminum(stranded)Conductor(A.A.C.)

Code word	Number and Diameter of wire in mm	Diameter of conductor in mm	Approximate weight of conductor in Kg/km	Approximate ultimate tensile strength of conductor in kg	Approximate current carrying capacity in amperes	
					At ambient temp of 40 <sup>0</sup> C	At ambient temp of 45 <sup>0</sup> C
Mantis	3/3.00	6.468	58	363	116	108
Aphis	3/3.55	7.223	72	394	133	123
Weevil	3/3.66	7.894	86	521	147	136
Lady-bird	7/2.79	8.374	117	737	178	165
Ant	7/3.10	9.30	144	892	204	189
Fly	7/3.40	10.20	174	1051	229	212
Blue battle	7/3.65	10.95	201	1203	252	234
Earwig	7/3.78	11.34	215	1272	264	245
Grass hopper	7/3.91	11.73	230	1356	275	255
Clegg	7/4.17	12.51	261	1523	298	276
Wasp	7/4.39	13.17	290	1673	318	295
Catter pillar	19/3.53	10.59	511	2985	460	386
Chafer	19/3.78	18.90	586	3381	504	468
Spider	19/3.99	19.95	652	3736	540	504
Cockroach	19/4.22	21.10	730	4144	575	534
Butter fly	19/4.65	23.25	886	4947	655	608
Moth	19/5.00	25.00	1025	5695	720	660
Locust	19/5.36	26.80	1176	6516	790	734
Maybug	37/4.09	28.63	1343	7289	850	790
Scorpion	37/4.27	29.89	1464	7878	895	830

Table-40

Particulars of Aluminum Conductor Steel Reinforced (ACSR) Conforming to  
I.S. 398-1961

Standard No min al Cop per area mm <sup>2</sup>	Stranding no. and wire diameter in mm.				Dia. Of compl ete conduc tor mm	Calcula ted equivale nt area of Alumin ium mm <sup>2</sup>	Approx ultimat e tensile strengt h of conduc tor Kg/mm <sup>2</sup>	Calculat ed resistanc e at 20 <sup>o</sup> C Ohms/k m	Approx.wt. in kg/km			Standar d length of conduc tor in mts	Approx. wt. of standard length kg
	Aluminium		Steel						Alumin ium	steel	Compl ete cable		
	No	Dia.	N o	Dia.									
13	6	2.11	1	2.11	6.33	20.71	771	1.374	57.5	27.2	84.7	2,500	212
16	6	2.36	1	2.36	7.08	25.91	952	1.098	71.9	34.1	106.0	2,00	212
20	6	2.59	1	2.59	7.77	31.21	1,136	0.9116	86.6	41.1	127.7	1,650	211
25	6	3.00	1	3.00	9.00	41.87	1,503	0.6795	116.2	55.1	171.3	1,220	209
30	6	3.35	1	3.35	10.05	52.21	1,860	0.5449	144.8	68.8	213.6	1,960	419
40	6	3.66	1	3.66	10.98	62.32	2,207	0.4565	172.9	82.1	255.0	1,600	408
45	6	3.99	1	3.99	11.97	74.07	2,613	0.3841	205.5	97.5	303.0	1,350	409
48	6	4.09	1	4.09	12.27	77.85	2,746	0.3656	215.9	102.5	318.4	1,280	408
50	26	2.54	7	1.90	12.66	82.83	2,923	0.3434	229.9	109.1	339.5	1,200	407
55	30	2.36	7	2.36	13.55	94.21	3,324	0.3020	261.4	124.0	385.4	1,060	409
65	30	2.59	7	2.59	14.15	103.60	3,299	0.2745	287.6	106.4	394.0	1,110	438
80	30	2.79	7	2.79	15.84	129.70	4,137	0.2193	359.8	133.8	493.6	885	437
80	30	2.54	7	1.90	15.86	128.51	4,638	0.2214	365.1	155.8	520.9	2,020	1,053
80	30	2.36	7	2.36	16.52	128.10	5,758	0.2221	363.4	240.4	603.8	1,960	1,184
85	30	2.59	7	2.59	18.13	154.30	6,880	0.1844	437.8	289.6	727.4	1,640	1,193
110	30	2.79	7	2.79	19.53	179.00	7,950	0.1589	508.1	336.1	844.2	1,410	1,191
130	30	3.00	7	3.00	21.00	207.00	9,127	0.1375	587.4	388.6	976.0	1,225	1,196
140	30	3.18	7	3.18	22.26	232.50	10,210	0.1223	660.0	436.6	1096.6	1,090	1,196
160	30	3.35	7	3.35	23.45	258.10	11,310	0.1102	732.2	484.5	1216.7	1,975	1,187
185	30	3.71	7	3.71	25.97	316.50	13,780	0.08889	898.2	594.2	1392.4	1,555	2,314
225	30	3.99	7	3.99	27.93	366.10	15,910	0.07771	1,093	687.3	1720.3	1,335	2,305
260	30	4.27	7	4.27	29.89	419.30	18,230	0.06786	1,190	787.2	1977.2	1,165	2,304
300	30	4.50	7	4.50	31.50	465.70	20,240	0.06110	1,321.5	874.2	2195.7	1,050	2,306
325	54	3.53	7	3.53	31.77	515.70	16,250	0.05517	1,463.6	537.9	2001.5	880	1,762



**Table- 41**

**Showing spacing between conductors of various capacity lines.**

S No.	Working Voltage	Spacing between conductors for		Spacing between conductor and supporting structures
		Vertical formation	Horizontal Formation	
1.	Low Tension	38cm	46 cm	15cm
2.	6.6kv or 11kv	76cm	1.14 metres	30.5cm
3.	33kv	1.22 metres	1.53 metres	61 cm
4.	66kv	1.96 Mts	3.23 Mts	76 cm
5.	110kv	3.13Mts	4.96Mts	1.07 Mts
6.	132kv	3.66 Mts	4.87 Mts.	1.30 Mts.

**Table -42**

**Material for stay wire**

Sl no	Specification of Material	Qty
1.	Stay rod of mild steel, galvanised, 16 mm diameter, 1.8 mt. long with forged hexagonal head on one side and threaded on the other end with next.	1 No.
2.	Mild steel anchor plate (also called stay plate ) 30cm x30 cm x 6.35 mm thick	1 No.
3.	Stay wire, 7/8 S.W.G., G.I. 8 Mts .long	8 Mts. Or 5 kg
4.	Stay clamp or pole clamp complete with nuts and bolts	1 No
5.	Stay bow made out of 12.7 mm dia .Mild steel rod complete with base plate	1 No.
6.	Stay insulator or egg insulator	1 No.
7.	Mild steel thimbles	2 Nos.
8.	Concreting of stay with R.C.C., cement concrete sand of ratio 1:2:4	0.5m <sup>2</sup>

reasonable limits the extent of the portion of the system affected by any failure of supply.

- (2) The supplier shall take all reasonable precautions to avoid any accidental interruptions of supply, and also to avoid danger to the public or to any employee or authorized person when engaged on any operation during and in connection with the installation, extension, replacement, repair and maintenance of any works.
- (3) The supplier shall send to the Inspector notice of failure of supply of such kind as the Inspector may from time to time require to be notified to him, and such notice shall be sent by the earlier practicable post after the failure occurs or after the failure becomes known to the supplier and shall be in such form and contain such particulars as Inspector may from time to time specify.
- (4) For the purposes of testing or for any other purposes connected with the efficient working of the undertaking, the supply of energy may be discontinued by the supplier for such period as may be necessary subject (except in cases of emergency), to not less than twenty-four hours' notice being given by the supplier to all classes of consumers specified by the Inspector likely to be affected by such discontinuance and in the event of any consumer or consumers from such classes of consumers objected, the supply of energy shall not be discontinued (except in cases of emergency), without the consent of the Inspector and subject to such conditions as he may impose.

**60. Text for resistance of insulation** -(1) Where any electric supply line for use at low or medium voltage has been disconnected from a system for the purpose of addition or alteration or repair, such electric supply line shall not be reconnected to be system until the supplier or the owner has applied the test prescribed under rule 48.

Table- 38  
 .Current Rating for A.C.S.R. Conductor for Overhead Lines.(I.S. 398-1961)

Code word	No of Aluminium wires	No of steel wires	Diameter of wire in mm	Number and diameter of wire in mm	Diameter of conductor in mm	Approximate weight of conductor in Kg/km	Approximate ultimate tensile strength of conductor in kg	Approximate current carrying capacity in amperes	
								At ambient temperature of 40 <sup>0</sup> C	At ambient temp of 45 <sup>0</sup> C
Squirrel	6	1	2.11	6/1x2.11	6.33	85	771	115	107
Gopher	6	1	2.36	6/1x2.36	7.08	106	952	133	123
Weasel	6	1	2.59	6/1x3.59	7.77	128	1136	150	139
Ferret	6	1	3.00	6/1x3.00	9.00	171	1503	181	168
Rabbit	6	1	3.55	6/1x3.35	10.05	214	1860	208	193
Mink	6	1	3.66	6/1x3.66	10.98	255	2207	234	217
Mink	6	1	3.99	6/1x3.99	11.97	303	2613	261	242
Raccoon	6	1	4.09	6/1x4.09	12.27	318	2746	270	250
Otter	6	1	4.22	6/1x4.22	12.66	339	2923	281	260
Cat	6	1	4.50	6/1x4.50	13.50	385	3324	305	283
Dog	6	7	4.72	6/1x4.72	14.15	394	3299	324	300
Leopard	6	7	5.28	6/1x5.28	15.84	493	4137	375	348
Tiger	30	7	2.36	30/7x2.36	16.52	604	5758	382	354
Wolf	30	7	2.59	30/7x2.59	18.13	727	6880	430	398
Lynx	30	7	2.79	30/7x2.79	19.53	844	7950	475	440
Panther	30	7	3.00	30/7x3.00	21.00	976	9127	520	482
Lion	30	7	3.18	30/7x3.18	22.26	1097	10210	555	515
Bear	30	7	3.55	30/7x3.55	23.45	1229	11310	595	552
Goat	30	7	3.71	30/7x3.71	25.97	1492	13760	680	630
Sheep	30	7	3.99	30/7x2.99	27.93	1726	15910	745	690
Dear	30	7	4.27	30/7x4.27	29.50	1977	18230	806	747
Eik	30	7	4.50	30/7x4.50	31.50	2196	20240	860	796
Mouse	54	7	3.53	54/7x3.53	31.77	2002	16250	900	835

## OVERHEAD INSTALLATION

### MAIN COMPONENTS OF OVER HEAD LINES:

The main components of an overhead lines are supports, cross-arms, clamps, insulators, conductors, guys, stays, lightning arresters, fuses, vee-guards, isolating switches, earth wires, guard wires, phase plates, bird guards, danger plate, barbed wire, beads for jumper etc.

### LINE SUPPORTS:

The function of line support is to support the conductors. The requirements of the line supports are:

- i) High mechanical strength.
- ii) Light in weight.
- iii) Cheaper in cost.
- iv) Good looking.
- v) Longer life.
- vi) Easy accessibility.

The choice of line supports for a particular situation depends upon the line span, cross-sectional area, line voltage, cost and local conditions. The line supports are of various types including wood, steel and reinforced concrete poles and steel towers etc.

### FACTORS GOVERNING HEIGHT OF POLE:

It depends on:

- i) The minimum clearance of the lowest conductor from the ground.
- ii) The number of conductors to be carried and minimum clearance should be maintained between conductors.
- iii) The length of the pole to be buried in the ground and generally  $1/6^{\text{th}}$  of the total length to be buried in normal soil.

### CONDUCTOR MATERIALS:

The most commonly used conductor galvanized steel and cadmium copper etc. It should be stranded not to solid one. Conductor cost is the major part of the total cost. So proper choice of conductor material is of almost importance. It should have the following characteristics:

- i) High electric conductivity.
- ii) High tensile strength.
- iii) Low specific gravity.
- iv) Low cost.
- v) Easy availability.

- vi) Should not be brittle.

### DETERMINATION OF SIZE OF CONDUCTOR FOR OVERHEAD LINE:

The size of the conductor is governed by the following factors:

- a) Line working voltage.
- b) Length of transmission line.
- c) Power to be carried.
- d) Power factor of the load.
- e) Permissible voltage drop in line.

### CROSS ARMS:

The function of cross arms is to keep the conductors at a safe distance from each other and from the pole. Cross arms are various types such as MS-channel, U-Shaped, V-Shaped, Zig Zag shaped etc. Cross arms shall be suitable and strong enough to withstand the resultant forces caused by insulators, their pins and dead weight of insulator attachments etc.

### POLE BRACKETS AND CLAMPS:

Clamps are made of flat iron & are used for fixing or holding service line stay wires, earth wire, shackle insulators, cross arms etc. In case of service lines, one end of the clamp is made longer and provided with an eye section.

### GUYS AND STAYS:

Stay is required for line supports and dead end positions as the poles take the pull due to conductors, minimum 30° angle is maintained between stay and pole. Stay set consists of MS rod of 19 mm dia, stay bow, check nut, thimbles, stay wires, stay clamp and CI anchor plate. One end of stay wire is fixed to the stay rod at the bottom and to the stay clamp to the pole. The stay or guy is tightened by means of a stay bow and anchor rod to the required tension. An egg type strain insulator is inserted in the guy wire for safety. It isolates stay wire electrically from metal support.

### CONDUCTORS CONFIGURATION, SPACING AND CLEARANCES:

#### Conductor configuration:

Generally horizontal, vertical and triangular configuration are commonly used. In unsymmetrical arrangement of conductors, the conductors are usually transposed at regular intervals in order to balance the electrical characteristics of various phases and prevent inductive interference with neighboring communication circuit.

Vertical configuration is the most economical for double circuit lines and horizontal configuration is for single circuit lines.

### Conductors spacing:

The spacing of conductors is determined by considering partly electrical and partly mechanical. Larger spacing causes increase in inductance of the line and hence the voltage drop, so that to keep the suitable spacing. An empirical formula commonly employed for determination of spacing of conductors for an aluminium conductor line is given below.

$$[\text{Spacing} = \sqrt{S + V/150}] \text{ meters}$$

Where S is say in meters  
& V is line voltage in KV

### SPAN LENGTH:

The length of the span depends upon the working voltage, higher the working voltage of the system, the greater will be the economical length of span owing to the higher relative cost of insulators to supports. It is not possible to give any hard and fast rule as to the best span length to be adopted. the usual spans are :

i)	With wooden poles	40 – 50 m
ii)	With steel tubular poles	50 – 80 m
iii)	With RCC poles	80 – 200 m
iv)	With steel towers	200 – 400 m and above.

### OVERHEAD LINE INSULATORS:

Insulators are mounted on the cross arms and the line conductors are attached to the insulators so as to provide the conductors proper insulation and also provide necessary clearances between conductors and metal work.

The important properties that an overhead line insulator must possess are:

- High mechanical strength.
- High relative permittivity.
- High insulation resistance.
- High ratio of rupture strength to flash over voltage.
- Ability to withstand large temperature variations.

### TYPES OF INSULATORS:

Various types of insulators are:

- Pin type insulators.
- Suspension insulators
  - Hewlet type
  - Cemented – cap type.
  - Core and link type.
- Strain insulators.
- Shackle insulators.
- Stay insulators.

### LIGHTENING ARRESTERS:

It is the device to protect the electrical equipment from damage due to lightening. When a voltage, high enough to damage the electrical equipment appears, the lightening arrestors provide a low impedance path from the phase wire to earth and short the high voltage effectively.

#### PHASE PLATES:

On each pole or tower of HT transmission lines phase plates indicating the different phases (red, yellow & blow) are provided.

#### DANGER PLATES:

On each pole or tower of HT transmission line a danger plate indicating the working voltage of the line & word "DANGER" is provided at a height of at least 2.4 m from the ground.

#### ANTI-CLIMBING DEVICES:

To safeguard against the climbing by unauthorized persons, GI barbed wire is placed around the poles at a height of about 2.5 M from the ground for at least 1 M. One towers it is provided at a height of 3 M to 4.5 M.

#### BIRD GUARDS:

These are in the form of wooden pieces of size about 10 cm x 12.5 cm x 15 cm in case of metal poles. The insulators are fitted over these wooden pieces known as "Bird Guards". These are used to avoid short-circuit or earth fault due to setting of birds, which may short circuit two line conductors or may earth one of the live conductors.

#### BEADS OF JUMPERS:

At certain places there are too many birds and due to their touching the jumpers and poles the failure of supply is most frequent. At such places to avoid birdage insulating beads are put all along the jumpers.

#### MUFFS:

The muffs are made of 3 mm thick sheet in two pieces, detachable 46 cm x 46 cm at the bottom and 30.5 cm x 30.5 cm at the top and overall length 1.8 M. For tubular poles these are of 25.4 cm diameter throughout and of length 1.8 M. These are used for concreting the poles of towers.

#### JUMPERS:

In a straight run, one terminal pole is provided after every one kilometer so as to facilitate sagging. The short length of the conductor used to connect the line conductor on one side of the terminal pole to the line conductor on the other side of

the terminal pole is known as the **Jumper**. It is made of the same material and has the same current carrying capacity as that of the line conductor.

TEE-OFFS:

The tee-off from a line should be taken only from a pole & not in the middle of the span. While taking branch line from all existing line for supporting villages / farms etc., it is essential that the correct phasing, phase to phase clearance and phase to earth clearance are observed.

GUARDING OF OVERHEAD LIENS:

A guarding is provided for the safety of the life, installations and of communications circuits. The guarding is provided at road crossings, canal crossings, railway crossing, crossings over LT lines or communication lines etc. The various guarding arrangements are **Cradle Guarding** and **Cage Guarding**. Guards should be uniformly spaced.



**LT Problem:**

Q. Prepare a material list for a 400 m long LT distribution line running from a substation with street light provided on each pole. There is a road crossing between 5<sup>th</sup> & 6<sup>th</sup> Pole and there is a deviation of 35° at 4<sup>th</sup> Pole and the total load is 80 KW. Assume after data.

Sol. Assume Data:

- Span between two poles is 50 m.
- Sag allowance for length of conductor is 1%.
- Supply voltage is 400V, 3Ø with 0.8 p.f.
- 0.5% extra is taken for bindings.
- T/F S/S is placed at the one end of the distribution line.
- Stay set will be provided at 1<sup>st</sup>, 4<sup>th</sup> & last pole.
- Street light is taken as HPSV lamp of 125W each.
- No. of wires (ACSR) = 5 (R, Y, B, N & Street light)

Calculation of Poles:

$$\text{Total nos. of poles} = \frac{\text{Total Span}}{50} + 1 = \frac{400}{50} + 1 = 9 \text{ Nos.}$$

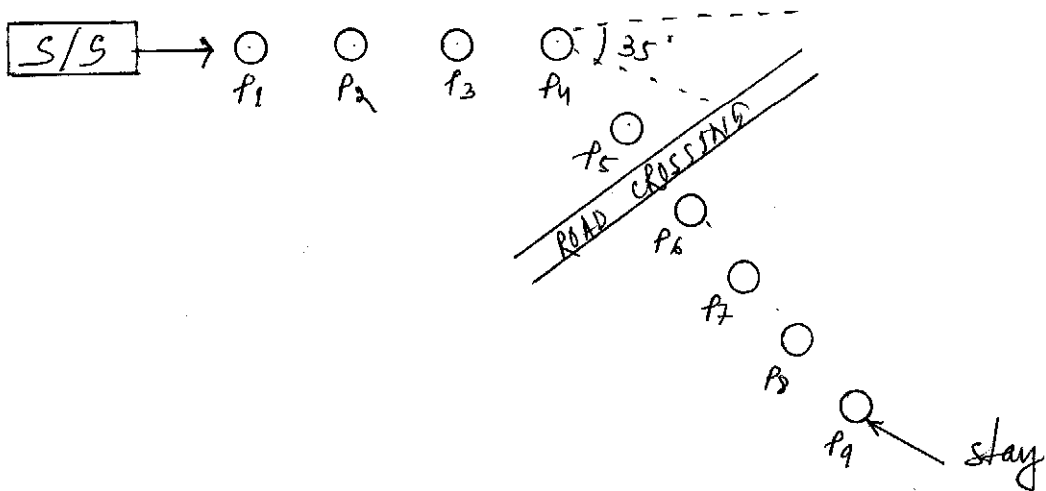

Calculation for load current & selection of conductors:

$$\text{Total given load} = 80 \text{ KW}$$

$$\therefore \text{Full load current, } I = \frac{80 \times 10^3}{\sqrt{3} \times 400 \times 0.8} = 144.33 \text{ A}$$

$$\& \text{ safe circuit current} = 1.5 \times 144.33 = \mathbf{216.5 \text{ A}}$$

Referring to ACSR Chart, we chose 6/1/3.66 mm size for phase wire with a resistance of 0.4565  $\Omega$  // km

$$\text{Total street light load} = 125 \times 9 = 1125 \text{ W}$$

$$\begin{aligned} \text{F.L. current for light,} &= 1125/230 = 4.89 \text{ A} \\ \text{\& safe circuit current} &= 4.89 \times 1.5 = 7.33 \text{ A} \end{aligned}$$

So, from the ACSR chart, we choose 6/1/2.11 mm size of conductor

For neutral wire, 50% rating of phase wire is taken

$$= \frac{216.5 + 7.33}{2} = 111.925 \text{ A}$$

$\therefore$  Referring the ACSR chart, we choose 6/1/2.11 mm size of wire for **neutral wire**.

Voltage Drop Calculation:

Length of wire = 400 + 1% sag. = 404 m.

Voltage drop for 404 m length for full load current of 144.33 A

$V_R =$  load current x resistance / km x length of conductor

$$= \frac{114.33 \times 0.4565 \times 404}{1000} = 26.618 \text{ v/ph.}$$

$$\therefore \text{Percentage regulation} = \frac{V_R \cos \theta}{V_{PH}} \times 100$$

$$= \frac{26.618 \times 0.8 \times 100}{400/\sqrt{3}} = 9.2\%$$

9.2% voltage regulation is so high, so we will choose next size of conductor from the ACSR chart, that means 6/1/3.99 mm size of ACSR with resistance of 0.384/  $\Omega$  // km

$$V_R = \frac{404 \times 144.33 \times 0.3841}{1000} = 22.39 \text{ v/ph.}$$

$\therefore$  Percentage regulation

$$= \frac{22.39 \times 0.8}{230} \times 100 = 7.7\%$$

Here, regulation is 7.7% and it is just more than 5% so, it may be allowed for selection of conduction.

$$\begin{aligned}
 \text{❖ Total length of phase wire} &= (404 + 0.5\%) \times 3 \\
 &= (404 + 2) \times 3 \\
 &= 1218 \text{ m}
 \end{aligned}$$

$$\begin{aligned}
 \text{❖ Total length of neutral wire} &= \text{Total length of street light Phase wire} \\
 &= 406 \text{ m.}
 \end{aligned}$$

Quantity of material calculation:

- No. of poles = 9 nos.
- Length of phase wire (6/1/3.99 mm size of ACSR) = 1218 m
- Total length of neutral wire (6/1/2.11 mm size of ACSR) = 406 m
- Total length of street light phase wire (-do-) = 406 m
- Total no. of cross arm = 9 Nos.

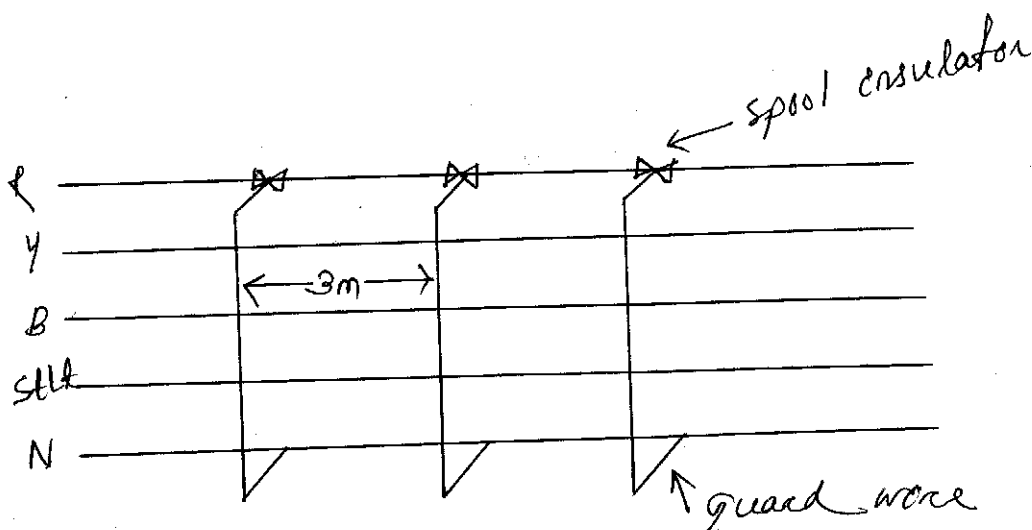

Material List:

Sl. No.	Description	Specification	Qty.	Unit	Remarks
1	Pole	7.5 m long PCC pole	9	Nos.	
2	Cross arm	1.11 m long, (75 x 40 x 6) mm MS channel X-arm	9	Nos.	
3	Back clamp with nut bolt	MS body (40 x 6 mm)	9	Nos.	For X-arm
4	Shackle insulator	L.T grade porcelain body glazed	20	Nos.	10 Nos. for P <sub>4</sub>
5	Pin insulator	L.T grade porcelain body glazed	24	Nos.	
6	Neutral knob	Cast Iron body Knob	6	Nos.	Only for intermediate pole
7	ACSR conductor	i) 6/1/3.99 mm size ACSR ii) 6/1/2.11 mm size ACSR	1218 612	m m	R,Y,B Neutral t street light
8	Guard wire	8 SWG, GI body	33	m	
9	Spool instrument	LT grade porcelain body	15	Nos.	
10	Cable for lightening	1.5 mm, Al. PVC insulated 2 core cable	18	m	2 m/Pole.
11	Light fitting	125 W, HPSV lamp with complete set.	9	Set.	01/Pole.
12	Binding wire	3 mm dia Al. wire	5	Kgs.	
13	Stay set	Complete stay set.	3	Set.	For P <sub>1</sub> , P <sub>4</sub> , P <sub>9</sub>
14	Danger board	-	9	Nos.	01/Pole.

### HT Problem:

Q. Estimate the materials required for 3 $\phi$ , 11KV overhead line feeder using ACSR size of 6/1/2.59 mm for 1.2 km length of the line WHICH will be tapped from an existing overhead line and terminate at pole mounted S/S and take span length is 100 m.

Solution:

$$\begin{aligned} \text{No. of Pole} &= \frac{\text{Total Span}}{100} + 4 \\ &= \frac{1.2 \times 1000}{100} + 4 = 16 \text{ Nos.} \end{aligned}$$

Here, 1<sup>st</sup> support point is 4-pole structure with disc insulator.

Space for drawing

P<sub>2</sub> to P<sub>12</sub> (11 Nos.) of single pole with pin insulators & P<sub>13</sub> or last pole have single pole with disc insulator.

ACSR size is given = 6/1/2.59 mm of ACSR.

Length of conductor = Total span + 2% sag + 2 m (extra)  
= 1200 + 24 + 2 = 1226 m / single line

$\therefore$  Total length of wire = 1226 x 3 = **3678 m**

#### Quantity of material calculation:

- No. of pole = 16 Nos.
- No. of v - cross arm = 12 Nos. (P<sub>2</sub> to P<sub>13</sub>)
- No. of top clamp = 12 Nos.
- No. of Disc Insulator = 12 Nos.
- No. of pin insulator = 11 x 3 = 33 (P<sub>2</sub> to P<sub>12</sub>)
- Conductor = 3678 m
- Stay set = 3 set.
- Cross arm (MS channel type) = 8 Nos. (for 4-pole structure)

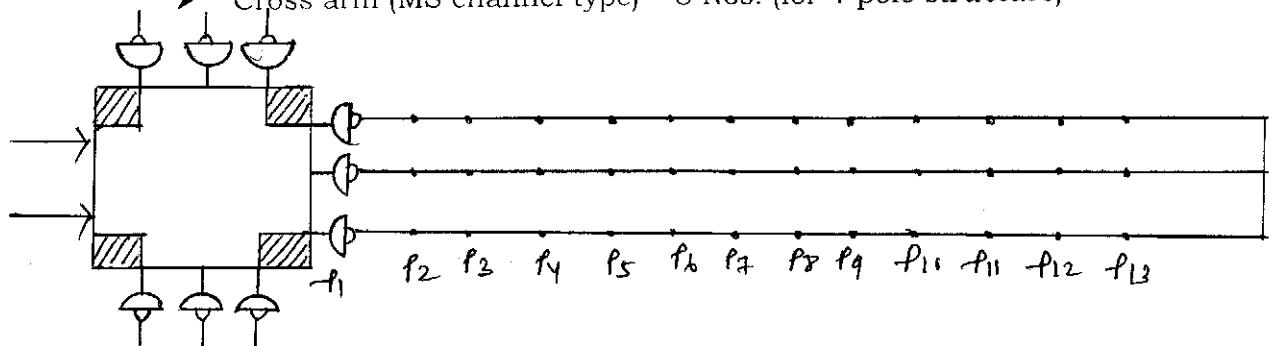

**Material List:**

Sl. No.	Description	Specification	Qty.	Unit	Remarks
1	Pole	MS Joist 9 m long	16	Nos.	
2	Cross arm	(100 x 50 x 8) mm & 2.7 m long with back clamp	8	Nos.	For 4-pole structure
3	V-cross arm	MS body V-shaped cross arm with back clamp	12	Nos.	P <sub>2</sub> to P <sub>13</sub>
4	Top clamp	MS Flat (40 x 40) mm size with nut bolt	12	Nos.	
5	Pin insulator	HT grade porcelain body glazed	33	Nos.	
6	Disc insulator	HT grade porcelain body glazed	12	Nos.	
7	Conductor	I6/1/2.59 mm size of ACSR	3678	m	
8	Binding wire	14 SWG Al. wire	3	Kgs.	
9	Stay set(3 sets): i) Stay clamp ii) Stay insulator iii) Stay site iv) Stay bow v) Anchor plate vi) Binding wire vii) Cement concrete	i) (40 x 6) mm GI body ii) HT grade porcelain body iii) 7/14 SWG GI wire iv) GI body v) GI body HT grade vi) 3 mm dia vii) —	3 3 24 3 3 3 As reqd.		
10	Danger plate	—	16	Nos.	= no. of pole

**Table -40**  
**Material Required for the Service Connection**

Sl no	Specifications	Qty
1.	19/2.24 mm dia or 70 mm <sup>2</sup> ,PVC insulated ,aluminium conductor 4 core,660 volts grade ,weatherproof cable	30 Mts.
2.	10 S.W.G. twin G.I. wire from pole earth wire upto Energy Meter board	30 Mts
3.	Pole clamp of ,mild steel with nuts and bolts to hold earth wire with pole	1 No
4.	G.I.pipe,35 mm diameter to carry cable for main board along wall upto floor pipe	6 Mts.
5.	G.I. pipe 50 mm diameter from outer wall upto underground concrete cable enclosure running below floor	4 Mts.
6.	G.I. pipe 35 mm diameter from concrete cable enclosure upto space for main board. through wall vertically	2 Mts.
7.	Conduit saddles of galvanized steel to hold G.I. pipe with wall at 70 cm's interval approximately	10 Nos.
8.	Hooked ray bolt 200 mm long 15 mm diameter to hold earth wire with wall.	
9.	G.I. pipe bends for 35 mm dia G.I. pipe .One bend is also required for a pipe running from concrete cable enclosure to Main board	4 Nos.
10.	Rag Bolts with nuts ,10 mm diameter 100 mm long to fix conduit saddles with wall	20 Nos.
11.	Iron clad board for installation of Main Board of size 100 cm x 75 cm	1 Nos.
12.	Rag bolts 15 mm dia with nuts 200 mm long to fix Main Board with wall	4 Nos.
13.	Bolt 10 mm dia 50 mm long to mount Energy Meter, Main switch, DPIC. Main switches ,distribution@ 4 bots each	20 Nos.
14.	Link clips of aluminium, 75 mm long to hold cable with support wire or Binding wire,12 SWG to hold cable along support wire or earth wire	2 pkts.
15.	Earthing thimbles 45 Amps rating with nuts and bolts to connect earth wire with Energy Meter board.	3 Mts.
		2 Nos.

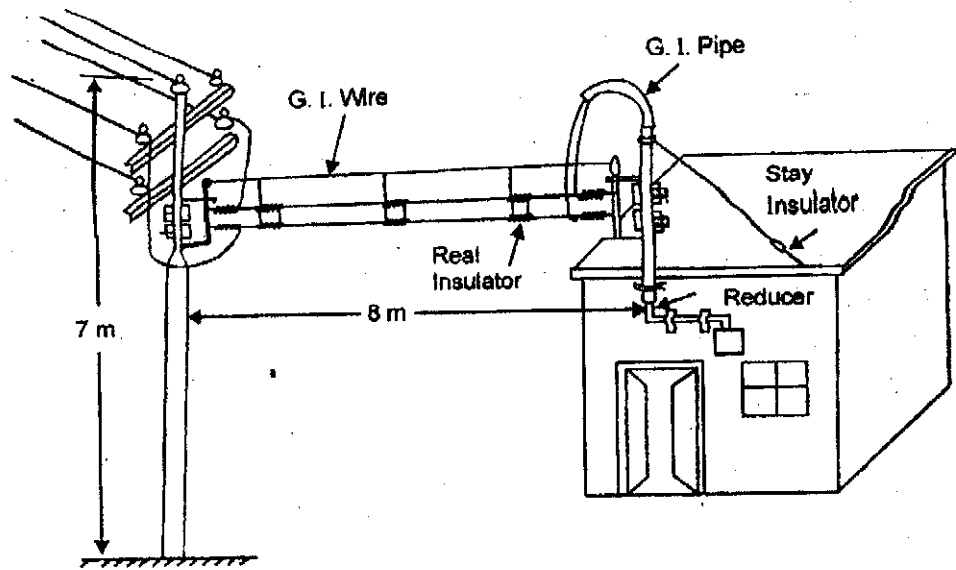

Fig.(III):5.12. Overhead service line for single storey building.

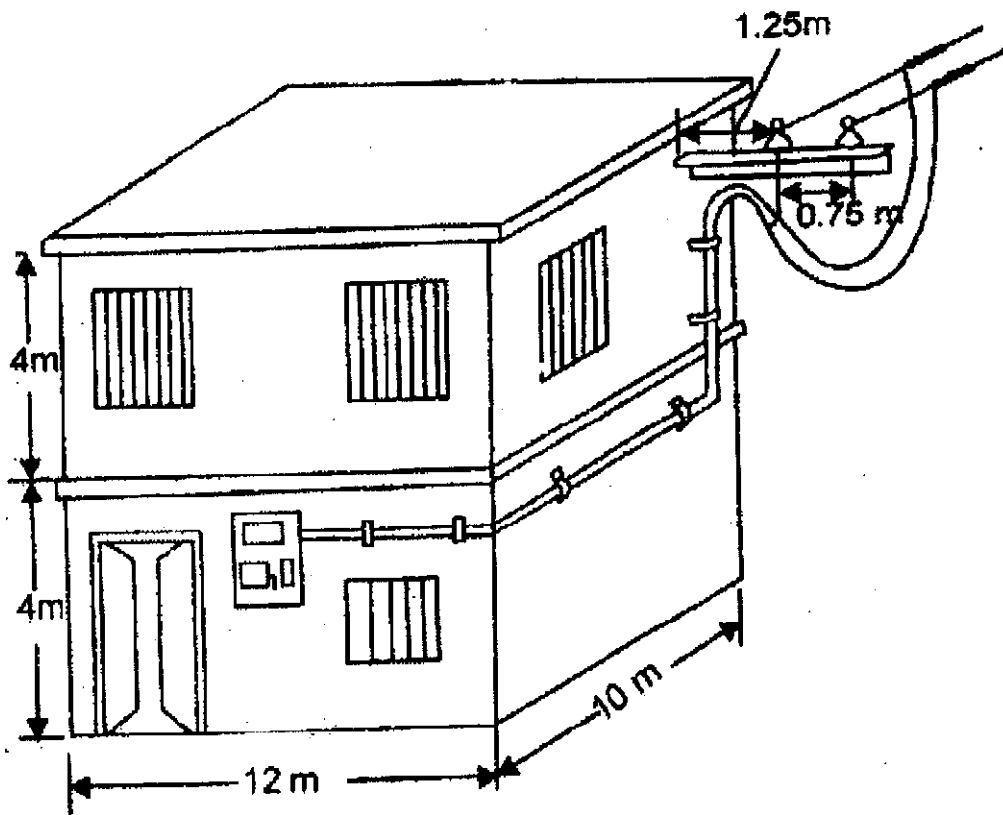

Fig.(III):5.13. Voverhead service line for double story building.



# Outdoor substation

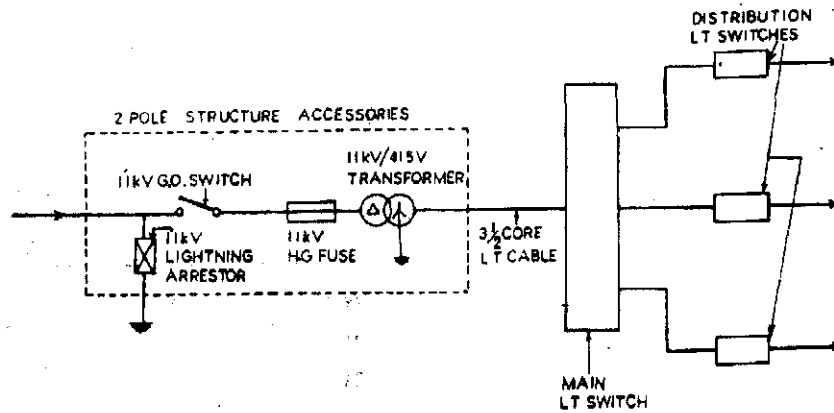

Figure 7.2: Single line diagram of a pole-mounted distribution substation.

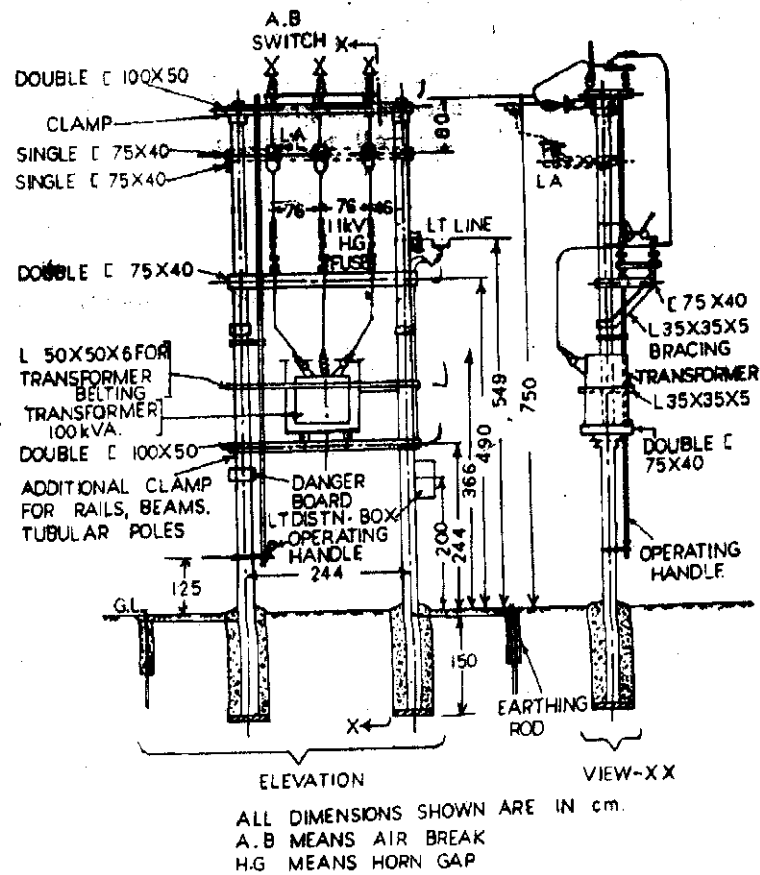

Figure 7.3: H-pole mounted substation with equipment.

Table -46

**Schedule of Material Required for 11/0.4kv outdoor substation.**

Sl.No.	Description of Material	Quantity
1.	<b>H.T. connection with main line</b> (i) M. s. channel 100 mm x 50 mm x 1.5 mt long (ii) H.T. 11 KV disc insulators with fittings (iii) Pin type insulator with pin for 11 kv (iv) Pole stay complete with fittings (v) Concreting of existing pole (vi) Earth wire clamp for holding earth wire with pole (vii) Tee clamp for M.S. channel (viii) Binding wire of aluminium	1 No. 3 set 2 Nos 2 set 1 No 1 No 1 No. 500 gms.
2.	<b>Fittings for double pole structure</b> (i) Stone pad for placing below the pole while erecting pole (ii) Fuse set complete (of the proper rating) (iii) Lightning arrestors (iv) M.S. channel 10 cm x 5 cm x 8 mm x 2.65 mt long (v) Eye bolt (vi) Dropper angle iron 75 cm x 75 cm x 8 mm x 2 mt long (vii) Stay complete with attachments (viii) 11 KV disc insulators with fittings (ix) Pin type insulators of 11KV with fittings	2 Nos. 1 set 3 Nos. 1 Nos. 3 Nos. 1 No. 2 Nos. 3 Nos. 3Nos.
	(x) Binding wire (xi) Danger plate with clamp and fittings (xii) Barbed wire (xiii) Earthing set complete (xiv) Jumpering (xv) Nuts and bolts of various sizes (xvi) Triple pole Air break, mechanically operated switch (xvii) Danger plate with clamp	500 gms 1 No. 5 kg 1 set 11 mts 18 Nos. 1 No. 1 No. 2 Nos.
3.	R.S. Joist 10 metres long 17.5 cm x 10 cm	
4.	ACSR conductor wesel size 6/1/2.59 mm length 25 x 3=75 metres from existing line to H type poles	80 mts.
5.	Galvanised steel earth wire for H.T. line 28 mts or 2.8 kg	2.8 kg
6.	Transformer 500 KVA 110/0.4 KV delta/star connected	1 No.
7.	Earthing sets complete (plate Earthing)	2 set
8.	LT, OCB, 800 amperes, complete with ammeter and voltmeter, KWH meter, C.T. 's and metering	1 set
9.	VIR cable, 11000 volts rating	40 mts
10.	Copper lugs 800 amperes	8 Nos
11.	L.T. Cubical for OCB of size 1.25 m x 1.25 m x 2 m	1 No
12.	Miscellaneous items such as kerosene oil, empire, tape, solder, aluminium flux, cotton waste	L.S
13.	N.L. (Neutral Link made of copper)	L.S
14.	Pole fencing with gate	L.S